

aeroqual<sup>oo</sup><sub>TM</sub>

# SM50

## USER GUIDE



Aeroqual Limited  
109 Valley Road, Mount Eden  
Auckland, New Zealand  
t +64 9 623 3013  
f +64 9 623 3012  
e [technical@aeroqual.com](mailto:technical@aeroqual.com)  
[aeroqual.com](http://aeroqual.com)

## Table of Contents

<b>User Guide Revision History .....</b>	<b>3</b>
<b>Description.....</b>	<b>4</b>
<b>1. Operating Instructions.....</b>	<b>4</b>
1.1. Power .....	4
1.2. Warm Up .....	4
1.3. Standard Inputs and Outputs.....	4
1.4. Using the Relay Output .....	5
1.4.1. Setting the Relay and Alarm Set Point.....	6
1.4.2. Connecting to the Relay Outputs .....	7
1.5. LED's.....	7
1.5.1. Status LED (Normal and Failure modes) .....	7
1.5.2. Relay LED (Coil energised) .....	7
1.6. Using the Analog 0-5V Output.....	8
1.7. Using the Serial Digital Communications.....	8
1.8. Topside connections.....	8
1.9. Underside connections .....	9
<b>2. Specifications.....</b>	<b>10</b>
<b>3. Mounting Dimensions.....</b>	<b>11</b>
<b>4. Appendix – Serial Protocol .....</b>	<b>12</b>

## User Guide Revision History

Document Number MRK-D-0011  
Product Version 4.2  
Description: User Guide for SM50

<b>Date</b>	<b>Revision Number</b>	<b>Description of change</b>	<b>Affected pages</b>
25/05/2015	V1.1	Removed old sensor spec, updated pictures	All
19/04/2016	V2.0	Updated new board specifications	All
05/05/2016	V2.1	Corrected checksum calcs in appendix	13-15

## Description

The Aeroqual SM50 range of gas sensor modules provides state of the art gas measurement in a flexible cost effective package. They utilise Aeroqual GSS Technology to provide reliable and sensitive measurement making them suitable for applications including low level ambient gas measurements, industrial process control, and leak detection. The modules use a fan based active sampling system. Please consult your Aeroqual Account Manager for further information.

Each SM50 module is calibrated to give a linear output with gas concentration. There are multiple outputs included as standard including diagnostic LED's, 0-5V signal, relay output, RS232, and RS485 digital communications.

Standard inputs include dipswitch settings for the relay.

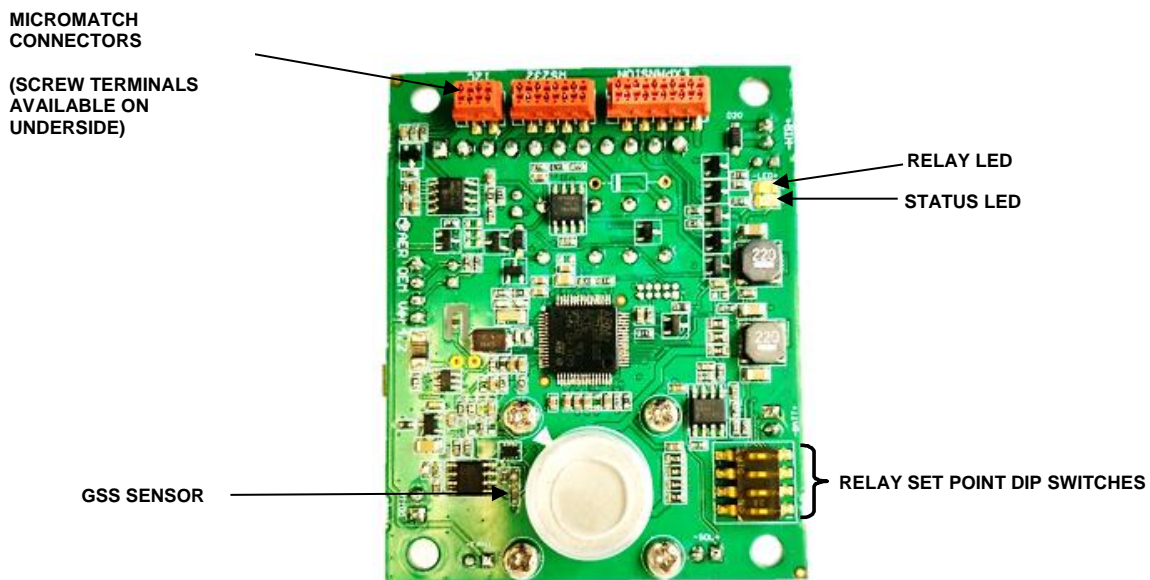

## 1. Operating Instructions

### 1.1. Power

The SM50 module will run off a DC input voltage in the range 11 - 32 VDC. Connect power to the V+ and GND screw terminal connectors or to the VIN and GND pins on the micromatch connectors. Power consumption varies depending on the SM50 sensor in the range 1 - 3 W.

### 1.2. Warm Up

The SM50 module is designed to run continuously. On first time use or after a period of non-use the SM50 module should be run for several hours to burn off contaminants on the sensor. When power is switched on the SM50 will warm up for up to 10 minutes before full operation.

### 1.3. Standard Inputs and Outputs

The SM50 sensor board contains a number of inputs and outputs as standard. These include:

- A 4-way DIP switch input for setting the relay set point
- LEDs for visual indication of sensor status and relay operation
- A 0-5V analog output which is proportional to the measured concentration
- A single pole double throw (SPDT) relay output for controlling external equipment
- A RS485 digital output to query the sensor
- A RS232 digital output to query the sensor

## 1.4. Using the Relay Output

The SM50 sensor module can be used as a simple gas sensitive relay switch to control devices or activate alarms using the on board relay. Three relay control software options are available: **AA**, **AB**, **C10**. The user should specify the software prior to delivery. The relay logic of the three software versions is described below. External equipment connected to the on-board relay should be wired appropriately to the normally open or normally closed contacts

**AA** Alarm-Above: the relay is programmed to energise or activate above the selected set point. Typical applications are health and safety alarm/warning systems or switching external equipment on and off. **This is the default software.**

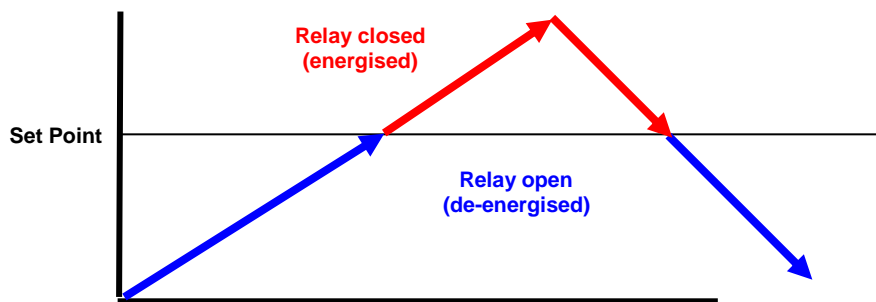

- When gas concentration is rising from below the “Set Point”, relay de-energised (relay NO=open, NC=closed)
- When gas concentration rises and reaches the “Set Point”, relay is energised (relay NO=closed, NC = open)
- When gas concentration drops and reaches the “Set Point”, relay de-energised (relay NO=open, NC=closed)

**AB** Alarm-Below: the relay is programmed to energise or activate below the selected set point. Typical applications are fail safe warning systems or controlling a gas generator.

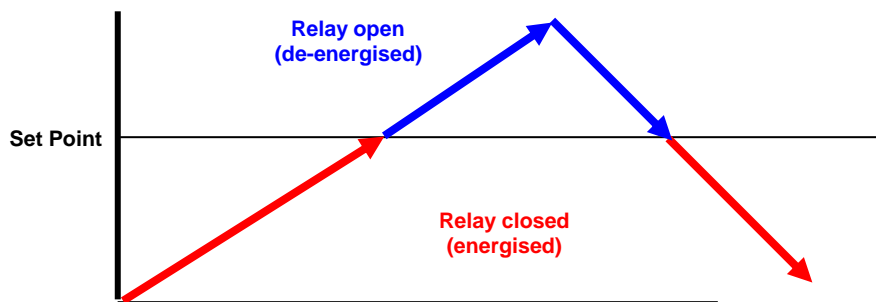

- When gas concentration is rising from below the “Set Point”, relay energised (relay NO=closed, NC = open)
- When gas concentration rises and reaches the “Set Point”, relay is de-energised (relay NO=open, NC = closed)
- When gas concentration drops and reaches the “Set Point”, relay energised (relay NO=closed, NC=open)

**C10** The relay is programmed to open and close around the selected control set point  $\pm 10\%$  to create a “control band”. Typical application is for maintaining a specific gas concentration between user defined levels through the control of an external device e.g. ozone generator.

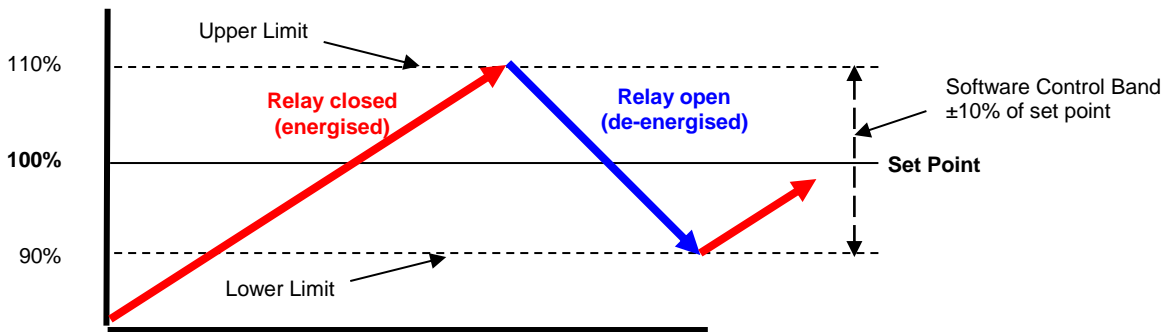

- When the gas level is rising from below “Lower Limit” to “Upper Limit”, relay is energised, (NO=closed, NC = open)
- When gas level is falling from above “Upper Limit” to “Lower Limit”, relay is de-energised (NO=open, NC = closed)

#### 1.4.1. Setting the Relay and Alarm Set Point

The Relay Set Point can be altered by adjusting the set-point dip-switches as shown below. The Relay Set Point is factory set (unless otherwise specified) to OFF-ON-OFF-ON. The set point levels for different dipswitch settings are provided below for some sensors. Contact Aeroqual if your sensor is not listed.

**Note:** The relay and sensor diagnostics are inactive during the warm up period.

Relay dipswitch (1 2 3 4)	O3 0-0.150 (ppm)	O3 0-0.500 (ppm)	O3 0-10 (ppm)
on on on on	0.000	0.000	0.00
off on on on	0.010	0.025	0.50
on off on on	0.020	0.050	1.00
off off on on	0.030	0.075	1.50
on on off on	0.040	0.100	2.00
<b>off on off on *</b>	<b>0.050</b>	<b>0.125</b>	<b>2.50</b>
on off off on	0.060	0.150	3.00
off off off on	0.070	0.175	3.50
on on on off	0.080	0.200	4.00
off on on off	0.090	0.225	4.50
on off on off	0.100	0.250	5.00
off off on off	0.110	0.300	6.00
on on off off	0.120	0.350	7.00
off on off off	0.130	0.400	8.00
on off off off	0.140	0.450	9.00
off off off off	0.150	0.500	10.00

\* Factory default setting

### 1.4.2. Connecting to the Relay Outputs

The relay output is a set of volt-free contacts that can be used to trigger an external device directly (max. 24V @ 1A) or for a higher voltage and current loads via a secondary relay. A typical external device is an alarm bell, siren, extractor fan, etc.

When the relay is energised (the red relay LED will light up) the normally open (NO) will be connected to common (COM) and the normally closed (NC) will be open with respect to COM.

Connect the desired external device to the normally open (NO), normally closed (NC) and COM contacts on the screw terminal as shown below.

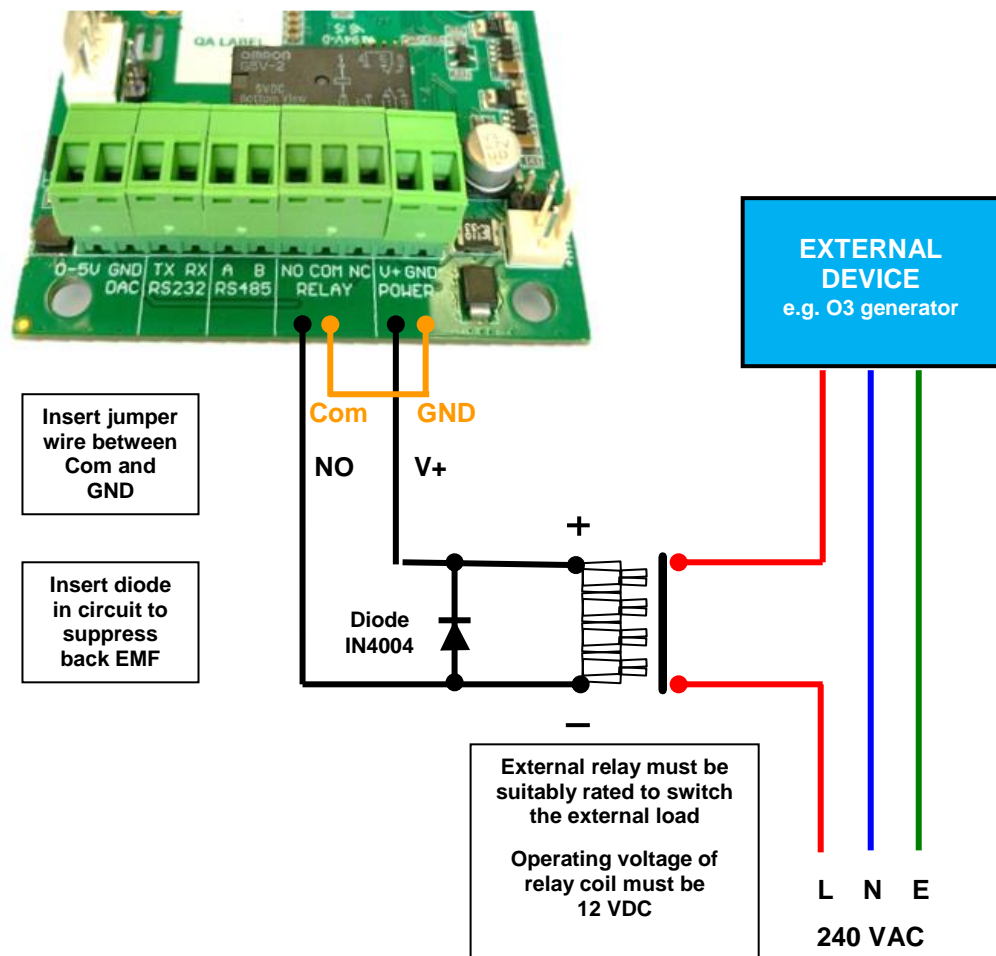

## 1.5. LED's

### 1.5.1. Status LED (Normal and Failure modes)

The Status LED glows GREEN and is located on the Sensor board. At start up, the Status LED will flash 2 to 6 times at an interval of 0.5 seconds. During the warm-up time the Status LED will flash at an interval of 2 seconds.

Normal status: Constant on

Sensor Failure: Flashes quickly at an interval of 0.3 seconds.

### 1.5.2. Relay LED (Coil energised)

The relay LED glows RED and is also located on the Sensor board. This LED comes on when the relay coil is energised.

## 1.6. Using the Analog 0-5V Output

The gas concentration is available as a 0-5V signal at the 0-5V and GND DAC connectors on the screw terminal block. 0 volts = zero ppm and 5 V = designated range of sensor (for example, a 0-0.5 ppm O<sub>3</sub> SM50 module would output 5V at 0.500 ppm ozone). The resolution of the analog signal is 12 bit.

**Note:** The 0-0.150ppm O<sub>3</sub> sensor analog output is 1.5V at 0.150ppm (full scale). All other sensors output 5.0V at full scale.

## 1.7. Using the Serial Digital Communications

Gas concentration data is available on the RS232 and RS485 digital communication channels. The RS485 channel is 2-wire, the RS232 is 2-wire plus GND. Connection is via the screw terminal connectors on the sensor board. The communication protocols for these serial interfaces are provided in the Appendix. Please note: the serial protocol is a proprietary binary protocol and is not ASCII. Hence a terminal program cannot be used to communicate with the SM50.

## 1.8. Topside connections

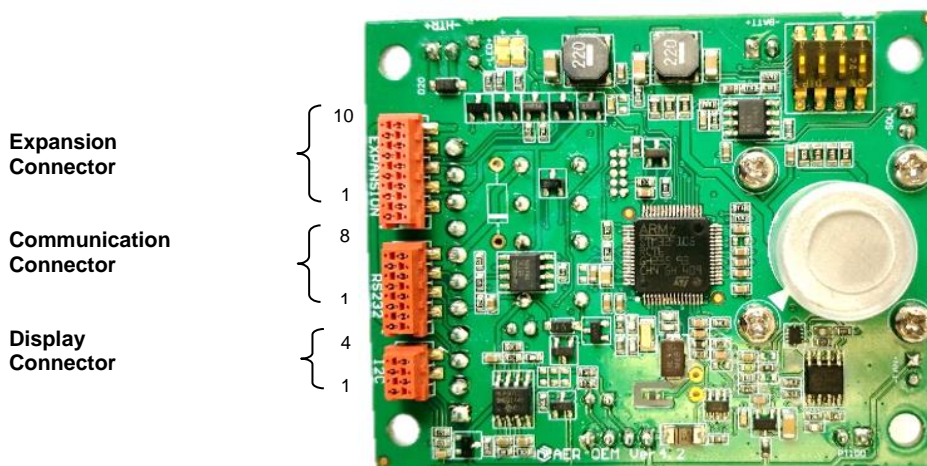

### Expansion Connector (Reserved – DO NOT USE)

PIN	1	2	3	4	5	6	7	8	9	10
CONFIG.	Reserved – DO NOT USE									

### Communication Connector

PIN	1	2	3	4	5	6	7	8
CONFIG.	VIN (11-32VDC)	GND	METER_TX (RS232)	METER_RX (RS232)	RS485A	RS485B	0-5V OUT (analog)	GND

### I2C Connector (Reserved – DO NOT USE)

PIN	1	2	3	4
CONFIG.	Reserved – DO NOT USE			



**1.9. Underside connections**



Plug in screw terminal connectors are supplied with the SM50.

**Plug in screw terminal connections**

PIN	1	2	3	4	5	6	7	8	9	10	11
CONFIG.	0-5V	AGND	TX	RX	A	B	NO	COM	NC	V+	GND
	DAC		RS232		RS485		RELAY			POWER	

## 2. Specifications

### Power

Input	11 - 32 VDC
Consumption	1 - 3 W max

### Outputs

0-5V analog	12 bit
SPDT Relay	Onboard 24VDC / 1A, NO, NC, COM
2 x LED indicators	Relay status Red = activated Sensor status Green = normal Green slow flash (2 seconds) = warming up Green fast flash (0.3 seconds) = failure
RS232	2-wire proprietary protocol (not ASCII)
RS485	2-wire proprietary protocol (not ASCII, not networkable)

### Inputs

Relay set points	4-way dip switch
------------------	------------------

### Diagnostics

If sensor failure then:-

Status LED	Fast green flash
Relay	AA version (energised) LED red AB version (de-energised) LED off C10 version (de-energised) LED off
0-5V analog output	5V

### Mechanical

Board Size	60 mm x 75 mm
Mounting	Screw or extrusion slot
Fan	On-board ball-bearing 50,000 hours
Sensor filter	On-board

### Environmental

Operating temperature	0°C to 50°C (-20°C to 50°C if enclosed)
Operating humidity	5% to 95% RH (non-condensating)

### Approvals



### 3. Mounting Dimensions

The mounting points and dimensions are given below for an SM50 ozone sensor. Individual SM50 modules may differ slightly to that shown.

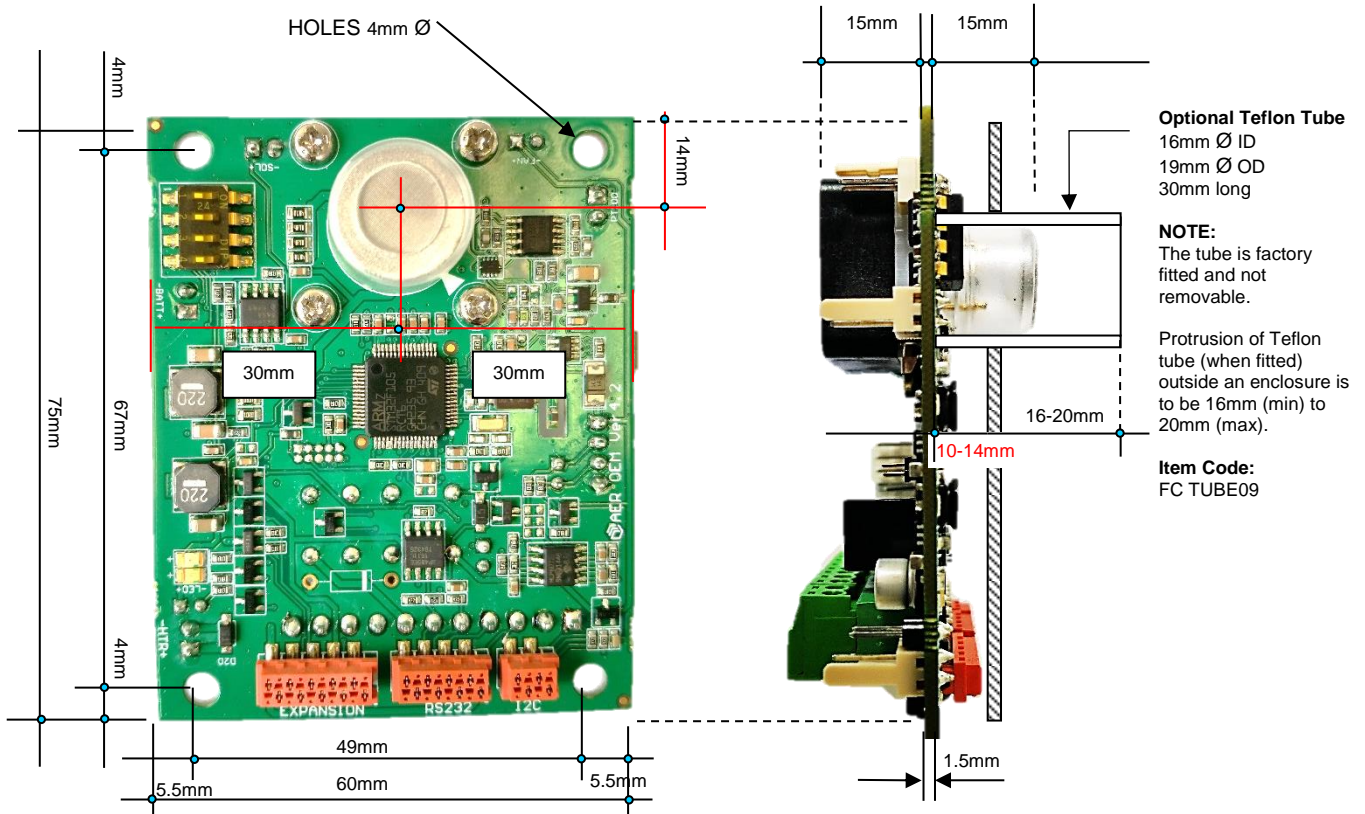

#### IMPORTANT

If the sensor is unplugged it is very important to plug the sensor back in with the correct orientation. Incorrect orientation will result in damage to the sensor and/or the board.

## 4. Appendix – Serial Protocol

Version: 2.3  
Released: 05-05-2016

The SM50 sensor board's digital information output is based on the following serial protocol. These command protocols are specified by Aeroqual Limited, all rights reserved. Aeroqual reserves the right to change the protocol without notification.

### Section 1. Communication settings and data representations.

Port:	RS232 Port	RS485 Port (2 wire)
Baud rate:	9600	4800
Data bits:	8	8
Stop bits:	1	1
Parity:	None	None
Flow control:	None	None

All floating point data values use IEEE754 32 bit floating point with little endian representation.

### Section 2. Commands.

This section details the communication commands used to transmit and receive information from the SM50 board.

#### 1. DATA REQUEST

The SM50 sensor data report. The data report frequency varies with sensor.

NOTE 1: This command behaves differently when using RS232 vs. RS85.

- When using RS232 the data report occurs automatically once per cycle (approx. once every 70 seconds). The SM50 board does not have to be polled when using RS232.
- When using RS485 the data report occurs only in response to a request command. The SM50 board does have to be polled when using RS485.
- 

NOTE 2: This request command has 4 different reply types. The data report reply occurs only once per cycle (approx. once every 70 seconds). If the SM50 is polled more frequently the other RESERVED replies will be received. These can be ignored.

Request command: DATA REQUEST

Length: 4 bytes

Structure:

Position	Size	Name	Value	Format
0	1 Byte	RECEIVER	0x55	
1	1 Byte	DATA REQUEST	0x1A	
2	1 Byte	RESERVED	0x00	
3	1 Byte	CHECKSUM	0x91 = 0x00 – (B0 + B1 + B2)	UINT8

Reply command 1: DATA REPORT

Length: 15 bytes

Structure:

Position	Size	Name	Value	Format
0	1 Byte	SENSOR	0xAA	
1	1 Byte	DATA REPORT	0x10	
2	4 Bytes	DATA1	Gas concentration in ppm	IEEE754 float
6	6 Bytes	RESERVED		
12	1 Byte	STATUS1	b1b0 = 00; Sensor OK b1b0 = 01; Sensor failure b1b0 = 11; Sensor aging	Only bits 1 and 0 are used to show status. Bits 2-7 can be ignored.
13	1 Byte	RESERVED	0x00	
14	1 Byte	CHECKSUM	CS = 0x00 – (B0 + ... + B13)	UINT8

Reply command 2: RESERVED

Length: 15 bytes

Structure:

Position	Size	Name	Value	Format
0	1 Byte	SENSOR	0xAA	
1	1 Byte	RESERVED	0x1A	
2	12 Bytes	RESERVED		
14	1 Byte	CHECKSUM	CS = 0x00 – (B0 + ... + B13)	UINT8

Reply command 3: RESERVED

Length: 15 bytes

Structure:

Position	Size	Name	Value	Format
0	1 Byte	SENSOR	0xAA	
1	1 Byte	RESERVED	0x0E	
2	12 Bytes	RESERVED		
14	1 Byte	CHECKSUM	CS = 0x00 – (B0 + ... + B13)	UINT8

Reply command 4: RESERVED

Length: 15 bytes

Structure:

Position	Size	Name	Value	Format
0	1 Byte	SENSOR	0xAA	
1	1 Byte	RESERVED	0x0F	
2	12 Bytes	RESERVED		
14	1 Byte	CHECKSUM	CS = 0x00 – (B0 + ... + B13)	UINT8

## 2. SENSOR INFO

The SM50 sensor information request.

Request command:

Length: 4 bytes

Structure:

Position	Size	Name	Value	Format
0	1 Byte	RECEIVER	0x55	
1	1 Byte	SENSOR INFO	0xFB	
2	1 Byte	RESERVED	0x00	
3	1 Byte	CHECKSUM	0xB0 = 0x00 – (B0 + B1 + B2)	UINT8

Reply command:

Length: 15 bytes

Structure:

Position	Size	Name	Value	Format
0	1 Byte	SENSOR	0xAA	
1	1 Byte	SENSOR INFO	0xFB	
2	1 Byte	VERSION NO		UINT8: Version x 10
3	1 Byte	DISPLAY FORMAT	0x01 = N.DDD e.g. 0.500 ppm 0x02 = NN.DD e.g. 12.20 ppm 0x03 = NNN.D e.g. 126.8 ppm 0x04 = NNNN. e.g. 2888. ppm	
4	1 Byte	NAME LENGTH		UINT8
5	7 Bytes	SENSOR NAME	Gas sensor name.	ASCII string. Valid bytes specified by NAME LENGTH.
12	2 Bytes	RESERVED		
14	1 Byte	CHECKSUM	CS = 0x00 – (B0 + ... + B13)	UINT8

### 3. CONVERSION FACTOR

The conversion factor to use when converting concentration from ppm to mg/m<sup>3</sup>.

Request command:

Length: 4 bytes

Structure:

Position	Size	Name	Value	Format
0	1 Byte	RECEIVER	0x55	
1	1 Byte	CONVERSION	0x2A	
2	1 Byte	RESERVED	0x00	
3	1 Byte	CHECKSUM	0x81 = 0x00 – (B0 + B1 + B2)	UINT8

Reply command:

Length: 15 bytes

Structure:

Position	Size	Name	Value	Format
0	1 Byte	SENSOR	0xAA	
1	1 Byte	CONVERSION	0x2A	
2	4 Bytes	FACTOR	Conversion factor.	IEEE754 float
6	8 Bytes	RESERVED		
14	1 Byte	CHECKSUM	CS = 0x00 – (B0 + ... + B13)	UINT8

This page is intentionally blank

Aeroqual Limited  
109 Valley Road, Mount Eden  
Auckland, New Zealand  
t +64 9 623 3013  
f +64 9 623 3012  
e [technical@aeroqual.com](mailto:technical@aeroqual.com)  
[aeroqual.com](http://aeroqual.com)