

Ozone Monitor

2B Technologies



OPERATION MANUAL

Models 106-MH and OEM-106-MH

© Copyright 2019, 2B Technologies
All rights reserved.

Technical Support:
<https://www.twobtech.com/tech-support.htm>
techsupport@twobtech.com
+1(303)273-0559

Contents

IDENTIFICATION RECORDS	iv
PRINTING HISTORY	v
WARRANTY STATEMENT	vi
WARNINGS	viii
1. OZONE MONITOR INTRODUCTION	1
1.1 Theory of Operation.....	1
1.2 Calibration Overview	2
1.3 The DewLine™.....	3
1.4 Instrument Default Settings	3
2. SPECIFICATIONS: Model 106-MH and Model OEM-106-MH	4
3. OPERATION	6
3.1 Shipping Box Contents.....	6
3.2 Operation of the Ozone Monitor	6
3.2.1 Overview	6
3.2.2 Operating Recommendations	7
3.3 The LCD Menu	8
3.4 Selecting the Main Menu	9
3.5 Making Measurements without Averaging or Logging	9
3.6 Data Averaging and Data Logging Using the Menu	10
3.6.1 To Average the Data without Logging.....	10
3.6.2 To Log Data.....	10
3.7 To Stop Logging Data.....	11
3.8 To Set the Time and Date	12
3.9 To Change the Ozone, Temperature, and Pressure Measurement Units	12
3.10 Measurement of the Zero Offset	12
3.11 To Set the Calibration Parameters	13
3.12 Collecting Data over the USB or Serial Port in Real Time	14
3.12.1 Data Acquisition Software	15
3.12.2 Determine the Connection Port and Baud Rate Settings	15
3.12.3 Data Output	15
3.13 To Change the Baud Rate.....	16
3.14 To Transmit Logged Data to a Computer Using the USB or Serial Port.....	16
3.15 Accessing the Serial Menu and the USB Menu	17
3.16 Collecting Data from the Analog Output.....	18
3.17 To Read the Number of Hours of Ozone Monitor Use	18
3.18 Using and Setting the Relay Limits	18
3.19 Lamp Test.....	19
3.20 LED Indicator Lights	20
4. MAINTENANCE/TROUBLESHOOTING	21
4.1 Overview.....	21
4.2 Maintenance Recommendations.....	22
4.3 Troubleshooting.....	22

5. CALIBRATION	26
5.1 Overview.....	26
5.2 Equipment Required.....	26
5.3 Instrument Preparation.....	27
5.4 Calibration Setup Preparation	27
5.4.1 Setup Check.....	28
5.4.2 Ozone Loss Test	28
5.4.3 Linearity Check.....	28
5.4.4 Intercomparison Test	29
5.5 Calibration Procedure.....	29
5.5.1 Instrument Preparation.....	29
5.5.2 Measurement of Zero Air	29
5.5.3 Measurement of Ozone Standards	29
5.5.4 Calibration Curve	30
6. PERIODIC ZERO AND SPAN CHECKS	31
7. LABELED INSTRUMENT PHOTOS	32
8. PARTS LIST	35
9. SERVICE LOG	36
Appendix A: Using the 2B Technologies Display and Graphing Software	38
Appendix B: Model 106-MH Cleaning Procedures (Flow Path)	42
Appendix C: Installation and Use of the USB Connection (for older versions of the Model 106 and/or Windows)	50

IDENTIFICATION RECORDS

Record the following information for future reference:

Unit serial number: _____

Warranty start date: _____
(date of receipt)

PRINTING HISTORY

This manual covers the Model 106-MH Ozone Monitor used for measurement of Medium-High ozone concentrations in air over a wide dynamic range extending from 0.10 parts-per-million by volume (ppm) to an upper limit of 10,000 ppm. It also covers the Model 106-OEM-MH Ozone Monitor, which does not have the enclosure and can be used for Original Equipment Manufacturer (OEM) applications. New editions of this manual are complete revisions that reflect updates to the instrument itself, as well as clarifications, additions, and other modifications of the text.

- Revision A February 2015
- Revision B-1 (instruments serial no. 942MH – 1031MH)..... July 2017
Addition of a second relay; 2-s data option.
- Revision B-2 (instruments serial no. 1032MH and above)..... July 2018
Scrubber plumbing changes (reflected in revised Figure 7.1a) and other clarifications to the text.
- Revision B-3 (instruments serial no. 1032MH and above)..... March 2019
Added Section 1.4. Corrections to flow rate in Specifications table. Corrected photo in Figure 7.3.
Other clarifications and minor edits to text.
- Revision B-4 (instruments serial no. 1032MH and above)..... March 2019
Updated photo in Figure 7.1a to show GEMS valve change.

TRADEMARKS & PATENTS

2B Technologies™, 2B Tech™, 2B™ and Ozone Monitor™ are trademarks of 2B Technologies.

CONFIDENTIALITY

The information contained in this manual may be confidential and proprietary and is the property of 2B Technologies. Information disclosed herein shall not be used to manufacture, construct, or otherwise reproduce the goods disclosed herein. The information disclosed herein shall not be disclosed to others or made public in any manner without the expressed written consent of 2B Technologies.

© Copyright 2019, 2B Technologies.
All rights reserved.

WARRANTY STATEMENT

2B Technologies, warrants its products against defects in materials and workmanship. 2B Technologies will, at its option, repair or replace products which prove to be defective. The warranty set forth is exclusive and no other warranty, whether written or oral, is expressed or implied. 2B Technologies specifically disclaims the implied warranties of merchantability and fitness for a particular purpose.

Warranty Periods

The warranty period is one (1) year from date of receipt by the purchaser, but in no event more than thirteen (13) months from original invoice date from 2B Technologies.

Warranty Service

Warranty Service is provided to customers via web ticket, email and phone support, Monday - Friday, from 9:00 a.m. to 5:00 p.m., Mountain Time USA. The preferred method of contacting us is through our web ticketing software at:

<https://www.twobtech.com/tech-support.htm>

This way all technical staff at 2B Tech will be alerted of your problem and be able to respond. When you receive an email reply, please click on the Ticket link provided to continue to communicate with us directly over the internet. The web ticket approach to customer service allows us to better track your problem and be certain that you get a timely response. We at 2B Tech pride ourselves on the excellent customer service we provide.

You may also contact us by email at techsupport@twobtech.com or by phone at +1(303)273-0559. In either case, a web ticket will be created, and future communications with you will be through that ticket.

Initial support involves trouble-shooting and determination of parts to be shipped from 2B Technologies to the customer in order to return the product to operation within stated specifications. If such support is not efficient and effective, the product may be returned to 2B Technologies for repair or replacement. Prior to returning the product, a Repair Authorization Number (RA) must be obtained from the 2B Technologies Service Department. We will provide you with a simple Repair Authorization Form to fill out to return with the instrument.

Shipping

2B Technologies will pay freight charges for replacement or repaired products shipped to the customer site. Customers shall pay freight charges for all products returning to 2B Technologies.

Conditions

The foregoing warranty shall not apply to defects resulting from improper or inadequate maintenance, adjustment, calibration or operation by customer. Maintenance, adjustment, calibration or operation must be performed in accordance with instructions stated in this manual. Usage of maintenance materials purchased from suppliers other than 2B Technologies will void this warranty.

Limitations of Remedies and Liability

The remedies provided herein are the Customer's sole and exclusive remedies. In no event shall 2B Technologies be liable for direct, indirect, special, incidental or consequential damages (including loss of profits) whether based on contract, tort or any other legal theory. The Ozone Monitor manual is believed to be accurate at the time of publication and no responsibility is taken for any errors that may be present. In no event shall 2B Technologies be liable for incidental or consequential damages in connection with or arising from the use of the Ozone Monitor manual and its accompanying related materials. Warranty is valid only for the country designated on the 2B Technologies quote or invoice.

WARNINGS

ENGLISH

**WARNING:**

Any operation requiring access to the inside of the equipment, could result in injury. To avoid potentially dangerous shock, disconnect from power supply before opening the equipment.

WARNING:

This symbol, , on the instrument indicates that the user should refer to the manual for operating instructions.

WARNING:

If this instrument is used in a manner not specified by 2B Technologies, USA, the protection provided by the instrument may be impaired.

FRANÇAIS

**ATTENTION:**

Chaque opération à l'intérieur de l'appareil, peut causer du préjudice. Afin d'éviter un shock qui pourrait être dangereux, déconnectez l'appareil du réseau avant de l'ouvrir.

ATTENTION:

Le symbole, , indique que l'utilisateur doit consulter le manuel d'instructions.

ATTENTION:

Si l'instrument n'est pas utilisé suivant les instructions de 2B Technologies, USA, les dispositions de sécurité de l'appareil ne sont plus valables.

ITALIANO

**ATTENZIONE:**

Qualsiasi intervento debba essere effettuato sullo strumento può essere potenzialmente pericoloso a causa della corrente elettrica. Il cavo di alimentazione deve essere staccato dallo strumento prima della sua apertura.

ATTENZIONE:

Il simbolo, , sullo strumento avverte l'utilizzatore di consultare il Manuale di Istruzioni alla sezione specifica.

ATTENZIONE:

Se questo strumento viene utilizzato in maniera non conforme alle specifiche di 2B Technologies, USA, le protezioni di cui esso è dotato potrebbero essere alterate.

CHINESE

**警告：**

任何需要接触设备内部的操作均可能造成人身伤害。为避免可能的触电危险，请在打开设备前切断电源。

警告：

这个符号 , 在仪器上表示用户应参考说明书上的操作指南。

警告：

如果仪器没有按照美国2B科技公司指定方式操作，仪器的保护性能会减弱。

ESPAÑOL

**ATENCIÓN:**

Cualquier operación que requiera acceso al interior del equipo, puede causar una lesión. Para evitar peligros potenciales, desconectarlo de la alimentación a red antes de abrir el equipo.

ATENCIÓN:

Este símbolo, , en el instrumento indica que el usuario debería referirse al manual para instrucciones de funcionamiento.

ATENCIÓN:

Si este instrumento se usa de una forma no especificada por 2B Technologies, USA, puede desactivarse la protección suministrada por el instrumento.

DEUTSCH

**WARNHINWEIS:**

Vor dem Öffnen des Gerätes Netzstecker ziehen!

WARNHINWEIS:

Dieses, , auf dem Gerät weist darauf hin, daß der Anwender zuerst das entsprechende Kapitel in der Bedienungsanleitung lesen sollte.

WARNHINWEIS:

Wenn das Gerät nicht wie durch die Firma 2B Technologies, USA, vorgeschrieben und im Handbuch beschrieben betrieben wird, können die im Gerät eingebauten Schutzvorrichtungen beeinträchtigt werden.

DUTCH

**OPGELET:**

Iedere handeling binnenin het toestel kan beschadiging veroorzaken. Om iedere mogelijk gevaarlijke shock te vermijden moet de aansluiting met het net verbroken worden, vóór het openen van het toestel.

OPGELET:

Het symbool, , geeft aan dat de gebruiker de instructies in de handleiding moet raadplegen.

OPGELET:

Indien het toestel niet gebruikt wordt volgens de richtlijnen van 2B Technologies, USA gelden de veiligheidsvoorzieningen niet meer.

JAPANESE

**警告：**

機器の内部で操作する時、怪我できます。危険な衝撃を回避するために、機器を開ける前に、電源を切断してください。

警告：

機器でこの記号 , を見れば、マニュアルを読んでください。

警告：

この機器は2Bテクノロジー会社、USAの指定でなければ、機器の保護が損なえます。

1. OZONE MONITOR INTRODUCTION

The 2B Technologies Model 106-MH Ozone Monitor is designed to enable accurate measurements of Medium-High concentrations of ozone in air over a wide dynamic range extending from 0.1 parts-per-million by volume (ppm) to an upper limit of 10,000 ppm based on the well-established technique of absorption of ultraviolet light at 254 nm. Note that throughout this manual and in the instrument output, “ppb” and “ppm” (identical to “ppbv” and “ppmv”) refer to parts-per-billion and parts-per-million by volume (not weight). The Ozone Monitor is lightweight (3.9 lb, 1.8 kg) and has a low power consumption (~6.0 watt) relative to conventional instruments and is therefore well suited for applications such as:

- long-term monitoring at remote locations where power is highly limited
- monitoring and control of ozone in industrial settings
- off-gas analysis in water treatment plants before ozone destruction

1.1 Theory of Operation

Absorption of UV light has long been used for measurements of atmospheric ozone with high precision and accuracy. The ozone molecule has an absorption maximum at 254 nm, coincident with the principal emission wavelength of a low-pressure mercury lamp. Fortunately, few molecules found at significant concentrations in the atmosphere absorb at this wavelength. However, interferences, such as organic compounds containing aromatic rings, can occur in highly polluted air.

Figure 1.1 is a schematic diagram of the Ozone Monitor. Ozone is measured based on the attenuation of light passing through a 6-cm absorption cell fitted with quartz windows. A low-pressure mercury lamp is located on one side of the absorption cell, and a photodiode is located on the opposite side of the absorption cell. The photodiode has a built-in interference filter centered on 254 nm, the principal wavelength of light emitted by the mercury lamp. An air pump draws sample air into the instrument at a flow rate of approximately 1 L/min. A solenoid valve switches so as to alternately send this air directly into the absorption cell or through an ozone scrubber and then into the absorption cell. The intensity of light at the photodiode is measured in air that has passed through the ozone scrubber (I_o) and air that has not passed through the scrubber (I). The ozone concentration is calculated from the measurements of I_o and I according to the Beer-Lambert Law:

$$C_{O_3} = \frac{1}{\sigma l} \ln\left(\frac{I_o}{I}\right)$$

where l is the path length (0.6 cm) and σ is the absorption cross section for ozone at 254 nm ($1.15 \times 10^{-17} \text{ cm}^2 \text{ molecule}^{-1}$ or $308 \text{ atm}^{-1} \text{ cm}^{-1}$), which is known with an accuracy of approximately 1%. The 2B Technologies instrument uses the same absorption cross section (extinction coefficient) as used in other commercial instruments.

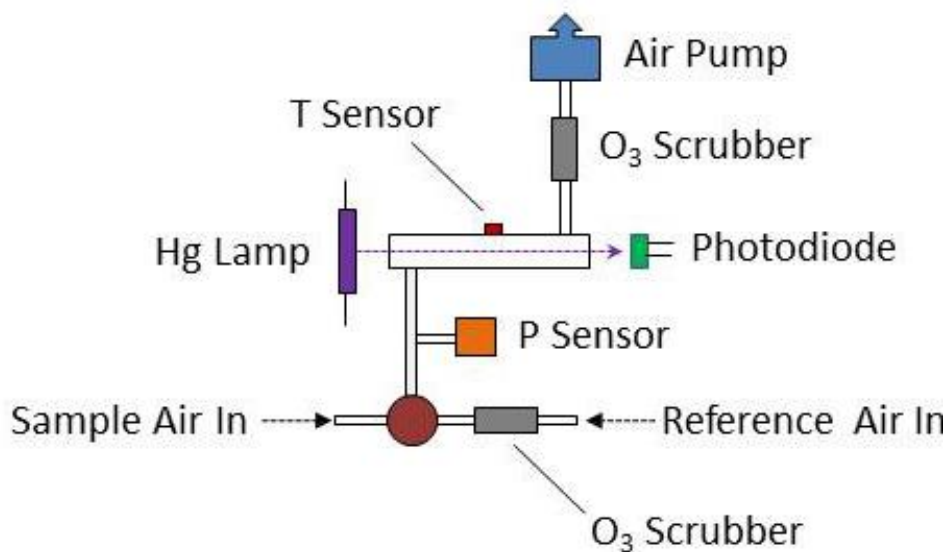

Figure 1.1. Schematic Diagram of the Ozone Monitor.

The pressure and temperature within the absorption cell are measured so that the ozone concentration can be expressed as a mixing ratio in parts-per-million by volume (ppm). The instrument displays and records the cell temperature and pressure in addition to the ozone mixing ratio. The cell pressure is displayed and logged in units of mbar or torr and the cell temperature in units of either °C or K.

1.2 Calibration Overview

In principle, the measurement of ozone by UV absorption requires no external calibration; it is an absolute method. However, non-linearity of the photodiode response and electronics can result in a small measurement error. Therefore, each instrument is compared with a NIST-traceable standard ozone spectrophotometer in the laboratory over a wide range of ozone mixing ratios. These results are used to calibrate the Ozone Monitor with respect to an offset and slope (gain or sensitivity). The corrections for offset and slope are recorded in the instrument Birth Certificate. These calibration parameters are entered into the microprocessor prior to shipment.

The user may change the calibration parameters from the front panel if desired. It is recommended that the instrument be recalibrated at least once every year and preferably more frequently. The user may perform the calibration (see Section 5), or return the instrument to 2B Technologies for calibration servicing.

The offset may drift due to temperature change or chemical contamination of the absorption cell. As discussed in Section 3.10 and Section 6 below, an accurate offset correction can be measured from time to time using the external ozone scrubber supplied with the instrument.

1.3 The DewLine™

Not shown on Figure 1.1 is the DewLine™, which serves to make the humidity entering the detection cell identical during I and I_o measurements. Please see our website for a technical discussion of the DewLine™ and its importance to ozone measurements: <https://www.twobtech.com/dewline.html>. Briefly, water vapor adsorbed to the inner wall of the detection cell changes the reflectivity of the cell. If humidity is not the same during I and I_o measurements, an offset in the ozone measurement will occur and can be up to several tens of ppb for sudden changes in ambient humidity. The offset will change with time as the internal ozone scrubber equilibrates with water vapor. Even for fixed-site ozone monitors, an offset measurement error will occur if the instrument is zeroed with dry tank air and then used to measure ozone in humid air. The DewLine™ solution to this often-ignored problem is unique to 2B Tech instruments.

1.4 Instrument Default Settings

When shipped, the instrument has the following default settings: Avg=10 s, offset=0, slope=1, T in °C, P in mbar, O₃ in ppm.

2. SPECIFICATIONS: Model 106-MH and Model OEM-106-MH

Measurement Principle	UV Absorption at 254 nm
Measurement Interval	2 s
Linear Dynamic Range	0-10,000 ppm
Resolution	0.1 ppm
Precision (1σ for 10-s average; aka rms noise)	Greater of 0.05 ppm or 2% of reading
Limit of Detection (10-s average, 2σ)	0.1 ppm
Accuracy	Greater of 0.05 ppm or 2% of reading
Baseline Drift	< 0.1 ppm/day, < 0.3 ppm/year
Sensitivity Drift	< 1%/day, < 3%/year
Calibration	NIST Traceable; annual calibration recommended
Measurement Time and Frequency	2 s, 0.5 Hz
Data Averaging Options	10 s, 1 min, 5 min, 1 hr
Response Time, 100% of Step Change	For 2-s output: 4 s, 2 data points For 10-s output: 20 s, 2 data points
Data Logger Capacity	32,736 lines (2-s meas. = 0.7 days; 10 s avg. = 3.7 days; 1-min avg. = 22.7 days; 5 min avg = 113 days)
Data Transfer Baud Rates	2400, 4800, 19200
Ozone Units	ppm, mg m ⁻³
Temperature Units	°C, K
Pressure Units	mbar, torr
T and P Corrected	Yes
DewLine™ for Humidity Control	Yes
Operating Temperature Range	0 to 50°C
Flow Rate	Minimum required: 0.2 L/min (200 cm ³ /min); Nominal: 1 L/min; Maximum: 1.5 L/min
Power Requirements	100-240 VAC, 50/60 Hz 11-28 V DC, nominally 500 mA at 12 V DC, 6 watt

Digital Data Outputs	USB, RS232, LCD display
Analog Data Outputs	0-2.5 V Analog, 4-20 mA; user-scalable in menu
Relays with 2 Setpoints	Two available: Relay 1 responds based on user's ozone set points. Relay 2 responds based on user's ozone set points OR responds based on diagnostics (T, P, flow, lamp voltage)
Bluetooth Option Available	Yes
Flow-Through Option Available	Yes
Size	Standard: 3.6 × 7.9 × 9.4 inches (9 × 20 × 24 cm) OEM: 2.5 × 7 × 9 in (6.4 × 17.8 × 22.9 cm)
Weight	Standard: 3.9 lb (1.8 kg) OEM: 2.4 lb (1.1 kg)
Options	Battery, Particle Filter, Bluetooth, Flow-Through Configuration

3. OPERATION

Please read all the following information before attempting to install the Ozone Monitor. For assistance, please call 2B Technologies at (303)273-0559.

NOTE:

Save the shipping carton and packing materials that came with the Ozone Monitor. If the Ozone Monitor must be returned to the factory, pack it in the original carton. Any repairs as a result of damage incurred during shipping will be charged.

3.1 Shipping Box Contents

Open the shipping box and verify that it contains all of the items on the shipping list. If anything is missing or obviously damaged, contact 2B Technologies immediately.

3.2 Operation of the Ozone Monitor

3.2.1 Overview

To operate the Ozone Monitor, connect it to an external power source and power the instrument on using the power switch. The instrument requires a 12 V DC source which can be supplied by: 1) the 100-240 V AC power adapter, 2) a cigarette lighter adapter plugged into a 12 V DC source such as found in an automobile or many light aircraft, or 3) a 12 V battery. The source can be in the range 11-28 V DC without any detrimental effects on the measurement. When using a battery, be certain to attach the positive (red) and negative (black) wires correctly. Batteries and battery chargers are available from 2B Technologies. A circuit breaker and diode are installed on the circuit board in case of an electrical short or incorrect battery attachment. If activated, the breaker will reset itself after a few minutes.

Lead-acid batteries are available from numerous manufacturers in a wide range of sizes and amp-hour ratings. The larger of these, such as those for automobiles or boats, will supply power for up to several weeks. Battery packs in the correct voltage range may be constructed from nickel-cadmium (rechargeable) or lithium (lightweight but not rechargeable) batteries for operation for a few hours. Battery options available through 2B Technologies may be found on our webpage: www.twobtech.com.

Once turned on, the instrument will display the version number of the software installed on the microprocessor. After a few seconds, the instrument will start displaying readings for ozone. The first dozen readings (requiring about two minutes) will be spurious, with large positive and negative swings due to the rapid warmup of the lamp and electronics. Also, ozone readings may be inaccurate during the 10-20 minutes required for the lamp, photodiode, and internal temperature of the absorption cell to stabilize.

Inlet tubing may be attached to the ¼ inch nylon Swagelok fitting on the back of the instrument. The inlet tubing should be made of PTFE (Teflon®), PFA, FEP, PVDF or some other inert material that does not destroy ozone and that does not desorb plasticizers and other organics that can contaminate the flow path. The length of tubing should be kept as short as possible (preferably not more than a few feet) to minimize ozone destruction within the inlet tubing. Tygon®, polypropylene (which may look like Teflon) and metal tubing should not be used. FEP-lined Tygon tubing, which is used inside the instrument provides the flexibility of Tygon with the inertness of FEP. A Teflon or PVDF inlet filter is highly recommended to prevent internal contamination of the tubing and absorption cell by particulate matter. The filter should be tested for ozone loss by measuring ambient ozone with and without the filter attached. Filters and filter holders are available through 2B Technologies.

Although the instrument compensates for temperature drift, if strong temperature fluctuations are expected, the instrument should be placed in a thermally insulated box.

3.2.2 Operating Recommendations

The following table gives a summary of the operating recommendations mentioned in this manual.

Operating Recommendation	Frequency	Section Reference
Allow ~20 minutes for instrument warmup before taking data	Each startup	3.2
Inlet tubing should be made of inert materials, such as PTFE, PFA, FED, PVDF (do not use Tygon®, polypropylene, or metal tubing)	Each use	3.2
Use a Teflon or PVDF inlet filter; test it for ozone loss	Each use	3.2
Check the zero offset	Occasionally	3.10, 6
Replace the ozone measurement scrubber	Every 6 months of continuous operation (~4,000 hours); otherwise annually	4
Perform multipoint calibration	<ul style="list-style-type: none"> • Annually • Any time major disassembly of components is performed • Any time the zero or span checks give results outside of the acceptable limits 	5
If strong temperature fluctuations are expected, place the instrument in a thermally insulated box	User-defined	3.2

3.3 The LCD Menu

Many aspects of the Ozone Monitor's operation may be accessed from the LCD menu. The following diagram summarizes the complete instrument Menu.

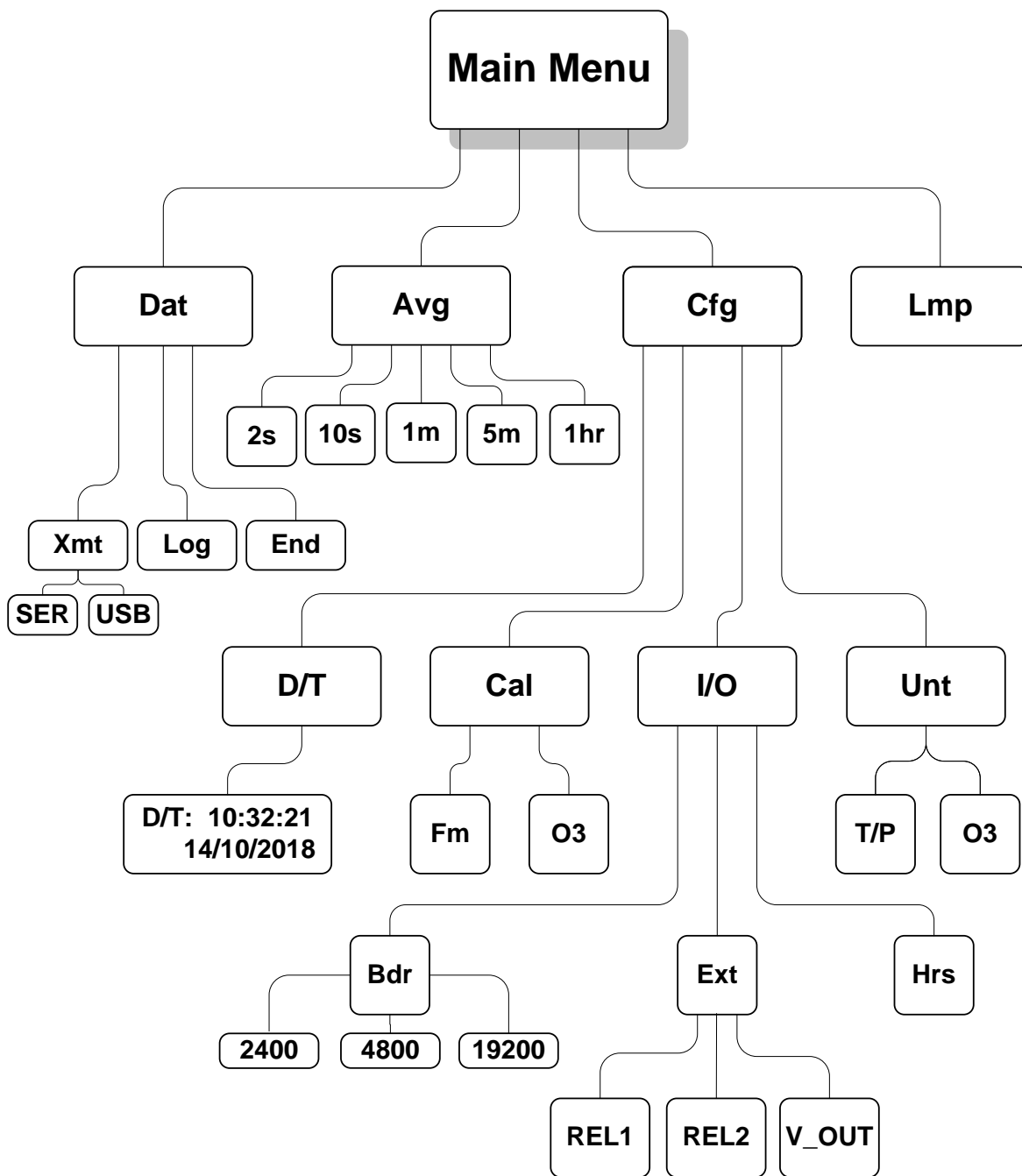

Figure 3.1. Instrument Menu

3.4 Selecting the Main Menu

When first turned on, the instrument will start making measurements. As described in Section 3.2.1, allow a ~20-minute warmup period.

The Main Menu is accessed using the black Select switch on the front panel of the instrument. To reach the Main Menu, press and *hold in* the Select switch until

Menu

is displayed, then release the Select switch. After a few seconds the Main Menu will appear:

Menu
Dat Avg Cfg Lmp ←

where **Dat**, **Avg**, **Cfg** and **Lmp** are submenus that may be selected. A blinking cursor will show across the **D** of the **Dat** submenu. The Select switch may be rotated clockwise or counterclockwise to move the cursor under the first letter of one of the other submenus. To select a particular submenu, move the cursor under the first letter of the submenu and momentarily press (“click”) the Select switch. To exit the Main Menu and begin making measurements again, select and click on the left arrow (←).

3.5 Making Measurements without Averaging or Logging

Select the **Dat** submenu from the **Main Menu** by rotating and then clicking the Select switch. The display will now show:

Dat Menu
Xmt Log End ←

Click on **End** to make measurements without logging new data. This will return you to the **Main Menu**. Select the **Avg** submenu and 2 s to make measurements without averaging. Click on ← to return to the **Main Menu** and click ← again to exit the Main Menu and start making measurements without logging or averaging. Note that “←” always takes you up one level in the menu.

The Ozone Monitor will then alternate every few seconds between displaying the most recent O₃ measurement along with other instrument measurements. For example, the display might read

O3= 0.3 ppm
T=33.3 P=989.7

where the current O₃ measurement is 0.3 ppm (by volume), the temperature is 33.3°C and the pressure is 989.7 mbar (see Section 3.9 below for setting other options for the units used for T, P, and O₃). A few seconds later, this display will be followed by

O3= 0.03 ppm
F=850 V=1.433

showing that the flow rate is 850 cc/min and the photodiode voltage is 1.433 volts.

3.6 Data Averaging and Data Logging Using the Menu

3.6.1 To Average the Data without Logging

Averaging modes are selected by choosing **Avg** from the **Main Menu**. Hold down the Select switch to obtain the **Main Menu**. Select and click on **Avg** to obtain the **Avg** menu:

Avg Menu
2s 10s 1m 5m 1h ←

Rotate the Select switch to move the cursor to **10s**, **1m**, **5m** or **1h** for averaging. Then click on the averaging time you want to use. You will be returned to the **Main Menu**. To exit the Main Menu and start acquiring data, click on ← again.

When “2s” is selected, the rapid raw output of the monitor is viewed every 2 seconds. When 10s is selected, the unit is in the default operating mode. In this mode, the average of five 2-s measurements is displayed and updated. When averaging for 1m, 5m, or 1h is selected, the two displays discussed above in Section 3.5 will alternate with a display such as

Avg O3= 63.5 ppm
19:55 05/02/19

for example, where the most recent average value of ozone computed is 63.5 ppm, the time of the measurement is 7:55 p.m. and the date is 5 February 2019.

Note that entering the menu will interrupt the averaging interval that is in progress, and the averaging interval will start over when the menu is exited and measuring is resumed.

Averaged data may be logged, thereby greatly extending the length of time that the internal data logger can be used (see next section).

3.6.2 To Log Data

Data may be logged in the internal data logger. Up to 32,736 data lines containing log number, ozone mixing ratio, internal (cell) temperature, internal (cell) pressure, flow rate, photodiode voltage, date and time may be stored in internal memory. Measurement output of 2 s, and averaging options of 10 s, 1 min, 5 min and 1 hr may be selected from the menu (see below), thereby allowing the instrument to operate and log data for 18 hours, 3.7 days, 22.7 days, 113 days and 3.7 years, respectively, before filling the memory.

To begin logging data, select the **Dat** submenu from the Main Menu using the Select switch. The display will now show

Dat Menu
Xmt Log End ←

To start logging data, rotate the Select switch to move the cursor to **Log** and click to select the logging mode. You will then receive the prompt:

Overwrite Data?
No Yes ←

Warning: If you start logging, all data previously stored in the logger will be irretrievably lost. If you have data in the logger that you want to keep, be sure to download it (see Section 3.14 below) before starting logging.

Click on **Yes** if you are sure you want to start logging new data. This will return you to the **Dat** submenu. Click on ← to return to the **Main Menu**, and click on ← again to exit the Main Menu and start making measurements. Note that “←” always takes you up one level in the menu.

When data are being logged, the log number and number of new measurements made for the next average (minus 1) are displayed in place of the data and time; e.g.,

Avg O3= 24.6 ppm
Log= 193:4

where **Avg O3** is the average ozone value most recently written to the logger, and the current log number is 193. The “4” in 193:4 refers to the number of 10-s data points that have been measured so far for inclusion in the next average to be displayed and logged. If 1-min averaging is used, this number will increment from 0 to 5; for 5-min averaging, the number will increment from 0 to 29; and for 1-hr averaging, it will increment from 0 to 359. This number is displayed so that the user will know how many more 10-s measurements need to be made before a new average is displayed and logged.

If there is a power failure while the instrument is in the logging mode, logging will resume after power is restored. A note of “Data Interruption” will be written to the logger prior to writing the first new data line. The instrument can accommodate multiple data interruptions due to power failures. For example, one can purposely switch the instrument off, move to another location and restart logging simply by turning the instrument back on. Data sets will be separated by the data interrupt message.

Note that entering the menu will interrupt the averaging interval that is in progress, and the averaging interval will start over when the menu is exited and measuring is resumed.

3.7 To Stop Logging Data

Hold in the Select switch to obtain the **Main Menu**. Go to the **Dat** submenu by clicking on **Dat**. Choose and click on the **End** function. This will end data logging. You may now return to the **Dat** submenu to transmit the data to a computer by clicking on **Xmt** (see below). The stored data will reside in memory (even when new measurements are being made) and can be transmitted using the **Xmt** function as often as you like. However, all stored data are lost once logging is started again using the **Log** function. Thus, you should always transmit your data to a computer before restarting logging.

If you fail to **End** logging prior to transmitting the data using the **Xmt** function, the instrument will automatically execute the **End** function for you prior to transmitting the data.

3.8 To Set the Time and Date

From the **Main Menu**, select the **Cfg** submenu. Next, select the **D/T** submenu. The display will read, for example:

**D/T: 14:32:21 ←
17/10/2018**

meaning that it is 21 seconds after 2:32 p.m. on October 17, 2018 (military time and European date). To change a number in the date and time, rotate the Select switch to underline the numeral you want to change. A single click then causes a blinking cursor to cover that numeral. The number can then be changed by rotating the Select switch. Once the number is correct, click on the Select switch to turn off the blinking cursor. You may now rotate the Select switch to choose another numeral to change. Once the time and date is correct, clicking on ← will set the internal clock to that time and return the display to the **Cfg** menu. As in setting a digital watch, the seconds should be set in advance of the real time since the clock starts to run again only when the set time is entered, in this case by clicking on ←.

3.9 To Change the Ozone, Temperature, and Pressure Measurement Units

From the **Cfg** submenu, choose the **Unt** submenu:

**Unt Menu
T/P O3 ←**

Choose O3 to change the ozone units:

**O3 Units Menu
Ozone: ppm ←**

Select **ppm**, depress the select switch to obtain a blinking cursor and rotate the select switch to choose between units of ppm and mg/m³. Press the select switch again to remove the blinking cursor, and return to the **Unt** menu using the left arrow. Ozone concentrations will now be calculated and reported in the chosen units.

Select T/P from the **Unt** submenu to change the temperature and pressure units:

**T/P Units Menu
T:C P:mbar ←**

You may now select units of °C or K for temperature and mbar or torr for pressure using the same procedure used to set the units for ozone concentration.

3.10 Measurement of the Zero Offset

The electronic zero of the instrument may be measured by attaching an ozone destruction cartridge to the air inlet for a period of 5-10 minutes. For an accurate measurement, the instrument must have been turned on long enough for the internal temperature to stabilize (normally ~20 minutes). The observed offset, which can amount to ± a few tenths of a ppm, can be corrected for by changing the offset calibration parameter (Z, in ppm) from the front panel, as described in Section 3.11.

3.11 To Set the Calibration Parameters

The instrument is calibrated at the factory, where slope (S) and offset (Z, in units of ppm for the Model 106-MH) parameters are entered into the instrument's memory. These preset calibration parameters are given in the instrument's Birth Certificate and recorded on the calibration sticker on the top of the absorption cell inside the instrument. However, the calibration parameters may be changed by the user. For example, it may be desirable to provide a positive offset by a known amount (e.g., 0.2 ppm) if the analog output is being used for external data logging, because the analog voltage output does not go negative below zero ppm, and the current output does not go below 4 mA. Because of noise and/or an inherent offset, some measured values will be below zero at very low ozone mixing ratios or while zeroing the instrument with an external scrubber. Also, the instrument zero may drift by a few tenths of a ppm over time. For this reason, frequent zeroing of the instrument using an external ozone scrubber to determine the offset is recommended. Any change in the slope (gain) of the instrument is likely due to a serious problem such as contamination, an air leak, obstruction of air flow, or loss of catalytic activity by the internal ozone scrubber, but it also can be adjusted. Once the zero of the instrument is corrected, the slope may be adjusted so that the instrument readout agrees with a standard ozone source (such as the 2B Technologies Model 306 Ozone Calibration Source™) or with the readout from another instrument whose calibration is considered to be accurate.

To change the calibration parameters, choose the **Cfg** submenu from the **Main Menu** and click on **Cal** to obtain the display

Cal Menu
Fm O3 ←

Click on the **Fm** submenu to display the calibration factor for the internal flow meter.

Fm Cal Menu
Fm= 0.92 ←

This is a multiplicative factor that will increase the flow rate if you increase the value. Adjust this value to correct the measured flow rate when comparing it to a calibrated volumetric flow meter connected to the inlet of the instrument.

Click on the **O3** calibration submenu to obtain, for example

O3 Cal Menu
Z= -0.40 S= 1.01

Here Z is the offset applied in units of ppm (in this case -0.40 ppm) and S is the slope applied (in this case 1.01). The value of Z is added to the measured ozone value, and the value of S is then multiplied by the measured ozone value. During calibration, Z is set to 0 and S set to 1.00; if the instrument reads an average of 0.6 ppm with the external scrubber in place, for example, the value of Z should be set to -0.6 in the O3 calibration submenu. If after correction for the zero, the instrument consistently reads 2% low, the value of S should be set to 1.02. Note that if calibrating the Model 106-MH in units other than ppm, the offset value must be converted to ppm before entering it as the Z value.

When the **Cal Menu** first appears, the **Z** will be underlined with a cursor. You may rotate the Select switch to choose the calibration parameter **S** or **Z**. A single click on **S** or **Z** will select that parameter for change and activate a blinking cursor. Once **S** or **Z** is selected, its value can be changed by rotating the Select switch to the left or right. After choosing the desired value, a click turns off the blinking cursor and allows you to scroll to the other parameter or to ← to exit the submenu. Once the values of **Z** and **S** are set, clicking on ← will return the display to the **Cfg** menu, and another click on ← will return to the **Main Menu**. The calibration parameters reside in non-volatile memory and are not affected by power failures.

In order to adjust the zero offset, after the instrument has warmed up for at least 20 minutes, attach the external ozone scrubber and make measurements for a few minutes. If the average of those measurements is 4 ppm, for example, subtract 4 from the current value of Z in the O3 calibration submenu; i.e., if Z was set to 3 during the measurements, change Z to -1. For more details about calibrating the ozone monitor against another instrument or calibrated ozone source, see the “Calibration” section (Section 5) of this manual or refer to Tech Note No. 15 at: https://www.twobtech.com/tech_notes/TN015.pdf

3.12 Collecting Data over the USB or Serial Port in Real Time

To transmit data to a computer over the USB or serial port in real time, connect the Ozone Monitor to the USB or serial port of the computer. Plug the cable in after powering the Ozone Monitor Model 106-MH to ensure correct functionality.

For the serial port connection, use the 9-pin cable provided. Note that this is a “straight-through” female-female serial cable. A “cross-over” cable will not work. The RS232 protocol is 2400, 4800 or 19200 baud as selected in the menu (see Section 3.13); 8 bits; no parity; 1 stop bit. The digital pinout for the RS232 is standard and as follows: Pin 2 = transmit, Pin 3 = receive, Pin 5 = ground. Looking at the back of the instrument, the pin numbers for the connector are:

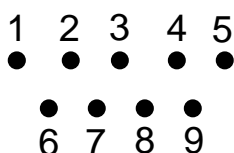

For connection to the USB port of the computer, use either (1) the serial port of the Ozone Monitor and a serial-to-USB cable, or (2) the USB port of the Ozone Monitor and a direct USB-A-Type to-USB-B-Type cable. If using the latter option, the USB driver will automatically enable data acquisition for newer versions of the Model 106 instruments (i.e., having two relays rather than one, serial no. ≥1004M) and computers running newer versions of Windows. If using earlier versions of the Model 106 and/or earlier versions of Windows, download the USB driver (<https://twobtech.com/downloads.html>) and follow the installation instructions that were in the manual that was included with your instrument (reproduced and updated in this manual as Appendix C).

3.12.1 Data Acquisition Software

Start your data acquisition software, preferably using the 2B Technologies Display and Graphing Software (available as a free download from the 2B Tech website, https://twobtech.com/docs/docs_software.htm). See Appendix A for a summary of working with this software. Other terminal emulation software such as HyperTerminal (a program provided with earlier versions of Windows) or [Tera Term](#) may be used as well.

3.12.2 Determine the Connection Port and Baud Rate Settings

When setting up your software or terminal emulator, choose the correct COM port listed in the Device Manager. If using Windows, go to the control panel and select System and Security > System > Device Manager. Select "Ports" to see the assigned serial or USB COM port number.

For the serial port, the baud rate setting in the data acquisition software must match the baud rate setting of the Model 106-MH (2400, 4800, or 19200). Adjust the setting in the software's setup menu and/or in the Model 106-MH's Cfg menu, following instructions in Section 3.13 below.

For the USB port, the baud rate setting in the data acquisition software must match the setting that the Model 106-MH had at startup. If you wish to change the baud rate of the Model 106, change it in both the instrument and the software, and then reboot the instrument to begin taking data.

3.12.3 Data Output

The ozone mixing ratio, internal cell temperature, cell pressure, date, and time are sent as comma-delimited ASCII text to the serial and USB ports every 2 seconds, 10 seconds, 1 minute, 5 minutes, or 1 hour, depending on the averaging time selected from the microprocessor menu. Time is provided in 24-hour (military) format, and the date is given in European style (day/month/year). The user should separately make note of the instrument settings for units (ozone, temperature, pressure), baud rate and averaging time.

A typical data line would read:

4.30,309.4,759.3,840,1.212,15/10/2018,18:31:27

where in this example:

Ozone = 4.30 ppm

Cell temperature = 309.4 K

Cell pressure = 759.3 torr (1 atm = 760 torr)

Flow rate = 840 cc/min (volumetric)

Photodiode Voltage = 1.212 volts

Date = October 15, 2018

Time = 6:31:27 pm

Units for ozone, temperature, and pressure will be output as set by the user in the **Cfg/Unts** menu.

If outputting logged data, the output serial data line will be preceded by the log number; e.g.,

2893,4.30,309.4,759.3,840,1.212,15/10/2018,18:31:27

where 2893 is the log number.

In addition to data lines, messages are written to the USB or serial port when logging is begun or ended, when transmission of data from the logger is begun and ended, when data collection is interrupted (e.g., due to a power failure), and when the averaging time is changed.

See Section 3.15 below for how to access the serial menu and USB menu.

3.13 To Change the Baud Rate

The baud rate for transmission of data to a computer over the USB or serial port may be changed by going to **Menu / Cfg / I/O / Bdr** to obtain:

Baud Menu
2400 4800 19200 ←

Choosing a baud rate will automatically return you to the **I/O** submenu.

3.14 To Transmit Logged Data to a Computer Using the USB or Serial Port

Connect the USB or serial port of the instrument to your computer using the appropriate cable (see Section 3.12). Enable a data acquisition program on the computer such as the 2B Technologies Display and Graphing Software, which can be downloaded at:

https://twobtech.com/docs/docs_software.htm

Appendix A gives a summary of working with this display software. Alternatively, HyperTerminal can be used (provided with early versions of Windows® platforms, usually in Start/All Programs/Accessories/Communications/HyperTerminal) or Tera Term, which can be downloaded at:

<https://twobtech.com/teraterm-4.100.exe>

The correct settings for receiving data are: chosen baud rate (2400, 4800, or 19200; see Section 3.12.2); 8 bits; no parity; 1 stop bit.

Click the Select switch to obtain the **Main Menu**. Go to the **Dat** submenu by clicking on **Dat**. Next, click on **Xmt**. The message “Logged Data” will be written to the USB or serial port, followed by a carriage return and all of the lines of logged data. After all data are transmitted, the message “End of Logged Data” and a carriage return are written. After transmission is complete, you can return to any position in the menu or resume ozone measurements. The logged data continues to be available for transmission until a new data log is started. Note that previously logged data are overwritten if logging is restarted.

3.15 Accessing the Serial Menu and the USB Menu

Measurements and logging tasks can be accessed via the serial port or the USB port using a terminal emulator such as [Tera Term](#) or HyperTerminal running on an attached computer or the [2B Technologies Display and Graphing software](#). Commands can be sent using the terminal emulator set with the properties listed in the section of this manual entitled “Collecting Data over the USB or Serial Port in Real Time” (Section 3.12). Listed below are the lower-case letters that are commands for performing certain operations while the instrument continues to measure:

- l** Start logging and write over existing logged data
- t** End logging and transmit logged data
- e** End logging
- h** Output serial data line header
- m** Access serial menu

If the letter **m** is sent as a command, **menu>** will be displayed in the terminal emulator window. When the serial or USB menu is accessed, the instrument is no longer making measurements; it is waiting for the next command to be entered. The following is the list of serial or USB menu items accessible from this point:

Menu Commands: Serial Port and USB Port

- l** Start logging and write over existing logged data.
- t** End logging and transmit logged data.
- e** End logging.
- h** Output serial data line header.
- a** Averaging time: enter a number followed by carriage return (0 = 2 second, 1 = 10 second, 2 = 1 minute, 3 = 5 minute, 4 = 1 hour)
- z** Zero (offset) calibration setting: displays current setting (in tens of ppb) and waits for a setting followed by a carriage return (enter a setting [integers only] and carriage return). The Z units here (tens of ppb) differ from the display units for Z (ppm).
- s** Slope calibration setting: displays current setting and waits for a setting followed by a carriage return (enter a setting and carriage return)
- c** Clock menu: displays current date and time and waits for **d** or **t** to be entered:
 - n** To exit without changing date or time
 - d** Asks to enter date in DDMMYY format
 - t** Asks to enter time in HHMMSS format
- Y** Set all configuration to default¹.
- n** Output instrument serial number.
- p** Perform Lamp test (carriage return to end test).
- o** Change relay 2 operation for diagnostics:
 - 1** Enable temperature inclusion for relay 2.
 - !** Disable temperature inclusion for relay 2.
 - 2** Enable pressure inclusion for relay 2.
 - @** Disable pressure inclusion for relay 2.
 - 3** Enable flow inclusion for relay 2.
 - #** Disable flow inclusion for relay 2.
 - 4** Enable pdv inclusion for relay 2.
 - \$** Disable pdv inclusion for relay 2.
- q** Change relay 2 operation for Ozone.
- ?** Output this help menu.
- x** Exit menu and return to measuring.

¹ Default settings: Avg=10 s, offset=0, slope=1, T in °C, P in mbar, O₃ in ppm, serial number resets to 1000. To reset to original serial number, use command **r** and password **bould**.

3.16 Collecting Data from the Analog Output

The data may be logged in real time using a data logger attached to the D9 connector on the back panel of the instrument using either a voltage or current recorder or data logger. The 0-2.5 V voltage output is measured across pins #1 (+) and #5 (ground). The 4-20 mA current output is measured across pins #9 (+) and #5 (ground). Looking at the back of the instrument, the pin numbers for the connector are:

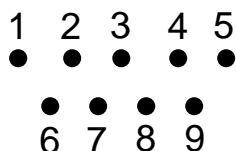

To change the analog output voltage scaling factor, go to **Menu / Cfg / I/O / Ext / VOUT**. If ppm are the selected units, for example, the display will briefly read “VOUT Menu” followed by

2.5V=00100 ppm
20mA=00100 ppm ←

In this example, the output scaling factor is set as 2.5 Volt (full scale) = 100 ppm; i.e. 1 Volt = 40 ppm. Also, the current output will be scaled such that the full scale of 20 mA corresponds to 100 ppm. A reading of zero ozone concentration will be output as 0 V and as 4 mA. You can use the Select switch to change the scaling factor to the value of your choice by selecting (press in) and changing (by scrolling) the individual digits in the scaling factor of either the voltage or current. Thus, the instrument is not limited to a fixed number of “ranges” common to most ozone monitors. Instead, any range can be defined.

3.17 To Read the Number of Hours of Ozone Monitor Use

The instrument keeps track of the total number of hours of use. This is helpful for determining when the instrument should be serviced, a pump replaced, etc. To read the number of hours of operation choose **Menu / Cfg / I/O / Hrs**.

3.18 Using and Setting the Relay Limits

The Ozone Monitor may be used to control other devices, such as ozone generators, using two 12-amp relays located on the back of the instrument. **REL1** (the bottom relay) may be used for ozone set points, for example to set limits for high levels of ozone. **REL2** (the top relay) may be used for a second set of ozone set points (for example, in the low ozone range), or instead could be used for diagnostics such as temperature, pressure, flow rate, or lamp voltage (accessed via the serial menu, Section 3.15).

To set the On and Off ozone limits of a relay, choose **REL1** or **REL2** from the **Cfg / I/O / Ext** submenu. The menu will show, for example:

On =00009.9 ppm
Off=00010.1 ←

With these settings, the relay will close (pass current) until the ozone concentration exceeds 10.1 ppm. Above this concentration, the switch relay will open. The relay will not close again until the ozone concentration drops below 9.9 ppm. In this way, for example, the ozone concentration from an ozone generator could be controlled in the range 9.9 to 10.1 ppm. You may now move the cursor using the Select switch to choose the digits in the On and Off relay settings: choose a digit to change by depressing the Select switch, and rotate the Select switch to change those settings. To choose another digit to change, depress the Select switch again to remove the blinking cursor.

Physical connection to the relay is made by means of a supplied screw connector for attaching wires to your device. The center terminal is common. When viewing the connector from the rear of the instrument, the terminal on the right is in normally open (i.e., it closes when the ozone concentration is below the first set point). This is the connection you would ordinarily use. The screw connector on the left is normally closed; i.e., it behaves in the opposite manner as the right screw terminal.

Please see our [Technical Note 45](https://twobtech.com/docs/tech_notes/TN045.pdf) for a detailed description of connecting to the relays and using them to control an ozone generator, alarms, or for creating a system override (https://twobtech.com/docs/tech_notes/TN045.pdf).

3.19 Lamp Test

If the instrument is excessively noisy (standard deviation greater than 0.1 ppm) or always reads near zero even in the presence of ozone, it is useful to perform the lamp test to make sure that the lamp is turning on and does not fluctuate too rapidly. Before performing the lamp test, allow the instrument to warm up for at least twenty minutes.

Choose **Lmp** from the **Main Menu**. The pump will go off and the display will momentarily read "**Lamp Test**". The photodiode voltage will then be displayed, and after a few lamp measurements have been made, the electronic offset and then a little later the standard deviation also will be displayed as, for example:

PDV= 0.89801 V
1.2+/-4.85 ←

The photodiode voltage (PDV) is a measure of the lamp intensity and should be in the range 0.6-2.2 volts. Since absorbance is a ratio measurement, the absolute value of the voltage is not particularly important. However, above 2.5 volts, which could occur if the instrument is allowed to become too hot, the photodiode is saturated and the calculated ozone concentration will be zero. A photodiode voltage less than 0.6 volts is indicative of either a weak lamp or a dirty detection cell and may result in a noisy measurement. The photodiode voltage will typically increase as the instrument warms up. Lamp drift is continuously monitored and corrected for in the firmware and thus has very little effect on the measured ozone concentration. Once the instrument is warmed up, fluctuations in photodiode voltage should be limited primarily to the last digit displayed. The lamp test also calculates an electronic offset and standard deviation of the measurement itself, displayed in the above example as 1.2 ppm for

the electronic offset and +/-4.85 ppm for the standard deviation. The standard deviation is a quantitative measure of the lamp and associated electronic noise. Electronic offsets should normally be -10 to 10 ppb equivalent. After running the lamp test for a few minutes, values above 5.00 for the standard deviation usually indicate an excessively noisy lamp. Lamps seldom “burn out” but may become noisy with time and need to be replaced. Some lamps become noisy after only a short period, while others will be extremely stable for years. If your lamp fails the lamp test during the first year of operation, contact us for a new lamp under the instrument warranty. Contamination of the detection cell may also cause a high standard deviation, in which case the flow path should be cleaned with methanol and the internal ozone measurement scrubber replaced. Please see Appendix B for detailed procedures if you want to perform these operations on site.

3.20 LED Indicator Lights

Four indicator lights are on the left side of the front instrument panel:

- The bottom light is a power indicator.
- The Low Lamp indicator comes on if the lamp voltage drops below 0.6 volts, indicating that a lamp test should be conducted (Section 3.19) and that the lamp may need replacement and/or the flow path may need cleaning.
- The Low Flow indicator comes on if the flow rate is less than 0.4 L/min. This indicates that there could be leaks, or that the air pump needs replacing. See the Maintenance/Troubleshooting Section of this manual (Section 4).
- The top light indicates the ozone level is above 100 ppb. If the Monitor is sampling ambient air, personnel in the vicinity should take precautions to avoid breathing unsafe levels of ozone.

4. MAINTENANCE/TROUBLESHOOTING

4.1 Overview

The Ozone Monitor is designed to be nearly maintenance-free. The only component that requires routine maintenance is the ozone measurement scrubber (see Figure 1.1 in Section 1), which should be changed at least annually, or after every six months (~4000 hours) of continuous operation. Also, the inlet filter (user supplied) should be changed as recommended by the filter manufacturer.

There are three internal ozone scrubbers (see Figure 7.1 of Section 7). Two are exhaust scrubbers, which are used to scrub ozone before the pump to protect the pump from high ozone damage; the other scrubber is for the ozone measurement. The ozone exhaust scrubbers do not need to be replaced unless they are visibly leaking material into the pump. The ozone measurement scrubber is connected to the inlet and the “long end” of the solenoid valve. This ozone measurement scrubber should be replaced every six months (~4,000 hours) of continuous operation; otherwise, annual replacement is recommended. To change the internal ozone measurement scrubber, remove the top cover by removing the six screws that hold it in place. The scrubber can easily be replaced by disconnecting the tubing attached to each end and connecting a new one in its place.

Other components with a limited lifetime are the air pump (~15,000 hours), lamp (~20,000 hours) and solenoid valve (rarely fails). It is recommended that the instrument be returned to 2B Technologies if any of these components fail. Alternatively, the user may install these components at their own risk. In that case, please contact 2B Technologies for instructions.

The following are indications of various instrument malfunctions.

Air Pump Failure: The instrument will not make a humming sound. Also, the circuit breaker may prevent the instrument from powering up if the motor in the air pump develops a short. The Low Flow indicator light (instrument front panel) will activate if the flow falls below 0.4 L/min.

Lamp Failure: The ozone measurements will be erratic and the Lamp Test will show 0.0 volts for the photodiode voltage. The Low Lamp indicator light (instrument front panel) will activate if the lamp voltage falls below 0.6 V.

Solenoid Valve Failure: The ozone readings will be low and average to close to zero if the solenoid valve is not switching. Partial switching of the solenoid valve will cause the instrument to read low but not zero.

Contaminated Flow Path: The instrument will typically have a large positive or negative offset and the ozone readings will be low once corrected for the measured offset.

4.2 Maintenance Recommendations

The following is a summary of recommended maintenance procedures mentioned in this manual.

Maintenance Recommendation	Frequency	Section Reference
Recalibrate instrument and clean flow path	At least once per year	1.2, 3.11, 5.1-5.5, Appendix B
Replace ozone measurement scrubber	every 6 months of continuous operation (~4,000 hrs); otherwise annually	4.1
Replace ozone exhaust scrubbers	As needed to protect pump (visual inspection)	4.1
Clean flow path (methanol)	As needed if instrument has large offset and ozone readings are low, or if readings are noisy	4.1; send instrument to 2B Tech (4.3), or follow cleaning procedures described in Appendix B

4.3 Troubleshooting

Help with troubleshooting is provided in the following table. Refer to Figures in Section 7.

Table I. *Troubleshooting the Ozone Monitor for performance problems.*

Problem/Symptom	Likely Cause	Corrective Action
<i>Instrument does not turn on.</i>	Power not connected properly or circuit breaker open.	Check external power connection for reverse polarity or a short and wait a few minutes for the thermal circuit breaker to reset.
<i>Instrument turns on then powers off.</i>	Burned out air pump.	Remove top cover and unplug air pump. Turn instrument on; if it remains running, then the air pump motor is burned out and shorting. Replace air pump.
<i>Display is blank or nonsense.</i>	Bad connection of display to circuit board.	Remove top cover and reconnect display to circuit board. Check solder connections to display. A new LCD may be required.
<i>Cell temperature reads low by several 10's of degrees.</i>	Absent or loose connection of temperature probe cable to circuit board.	Remove top cover and reattach connector to circuit board.

Problem/Symptom	Likely Cause	Corrective Action
<i>Readings are noisy with standard deviations greater than 0.2 ppm when measuring a zero.</i>	<p>Lamp output is weak, below 0.6 V on Lamp Test.</p> <p>Flow path contaminated.</p>	<p>Remove top cover and check lamp connection to circuit board. Run Lamp Test from menu. If photodiode voltage is less than 0.6 V, replace lamp.</p> <p>Clean flow path with methanol according to the Cleaning Procedure.</p>
<i>Analog output is constant or does not track front display.</i>	<p>Cable not properly connected between analog output and recording device.</p> <p>Wrong scaling factor selected In menu.</p>	<p>Check continuity of your analog cable to your recording device and make sure correct connector pins are being used.</p> <p>Check and reset analog output scaling factor in the Menu.</p>
<i>Select switch does not work.</i>	Bad solder joint to circuit board or damaged select switch.	Remove top cover and check solder connection to select switch. It may be necessary to replace the select switch.
<i>Serial port does not work.</i>	<p>Wrong serial cable used.</p> <p>Wrong baud rate selected.</p>	<p>A “straight through” serial cable is provided. Some data collection devices require a “cross over” cable in which pins 1 and 3 are exchanged between the two ends of the cable. Use a “cross over cable or additional connector that switches pins 1 and 3.</p> <p>Make sure that the baud rate chosen in the menu matches the baud rate setting of your data acquisition program.</p>

Problem/Symptom	Likely Cause	Corrective Action
<p><i>Required calibration parameters are large (>±1 ppm offset and/or >±9% slope) when calibrated using a standard ozone source or reliable ozone instrument.</i></p>	<p>Ozone scrubber is contaminated.</p> <p>Flow path is contaminated.</p> <p>Solenoid valve is contaminated and not opening and closing properly.</p> <p>Air pump is not drawing sufficient flow.</p>	<p>Replace ozone scrubber. Be sure to use an inlet filter to remove particulate matter.</p> <p>Clean flow path with methanol following the Cleaning Procedure.</p> <p>Remove top cover, unplug pump, turn instrument on and test listen for clicking of solenoid valve every 2 seconds. If solenoid valve is clicking, remove tubing connections and test solenoid valve to confirm that air always flows through common and alternately through normally open and normally closed states.</p> <p>Replace solenoid valve is not working properly. This requires soldering.</p> <p>As a first check, hold your finger over the air inlet to determine whether air is being drawn in. If there is flow, measure the flow rate by attaching a high conductance flow meter to the air inlet. Air flow should be greater than 0.6 L/min. If flow is lower, check for leaks. If there are no leaks, replace air pump.</p>

2B Technologies offers reasonably priced customer service for instrument repairs. The calibration service includes cleaning of the entire flow path with methanol, testing of all components for proper function, installation of a new internal ozone scrubber and calibration against a NIST-traceable standard. The best way to contact us for

service is to log a customer service ticket at <https://www.twobtech.com/tech-support.html>. Normally, you will hear back from us by email within a few hours. Or, call us at +1(303)273-0559.

There is a great deal of technical information about our instruments posted as technical notes at https://www.twobtech.com/docs/docs_tech_notes.htm. Manuals, brochures, software, cleaning procedures and scientific papers may be downloaded at <https://www.twobtech.com/downloads.html>.

5. CALIBRATION

5.1 Overview

Every analytical instrument is subject to some drift and variation in response, making it necessary to periodically check the calibration. Dynamic calibration is a multipoint check where gas samples of known concentration are sampled by the instrument in order to determine a calibration relationship. For more information on calibration of ozone monitors refer to the Code of Federal Regulations ([Title 40, Part 50, Appendix D](#)) and the EPA's [Technical Assistance Document for the Calibration of Ambient Ozone Monitors](#).

Calibration is the process of adjusting the gain and offset of the Model 106 Ozone Monitor against some recognized standard. The reliability of the data collected from any analytical instrument depends on the accuracy of the calibration, which is largely dependent upon its analytical traceability to a reference material or reference instrument calibration.

Because of the instability of ozone, the certification of ozone concentrations in a compressed gas cylinder is impossible due to loss of ozone over time. When ozone concentration standards are required, the ozone must be generated and certified on site. The following are based on EPA requirements for calibrations of ozone monitors for monitoring in compliance with the Clean Air Act. Similar procedures are recommended for other applications as well.

Ozone standards can be classified into two basic types:

1. A **Primary Ozone Standard** is the combination of an ozone generator and an ozone monitor based on UV absorbance (a UV photometer) that has been setup in accordance with the procedures prescribed by the U.S. Environmental Protection Agency (EPA) under Title 40 of the Code of Federal Regulations, Part 50, Appendix D (40 CFR Part 50).
2. An **Ozone Transfer Standard** is a system (a portable ozone monitor and/or a portable ozone generator), which can produce accurate ozone concentration standards which are quantitatively related to a primary ozone standard. An example of an ozone transfer standard is the 2B Technologies Model 306 Ozone Calibration Source. Ozone transfer standards must be certified before use in accordance with the procedures prescribed by the U.S. Environmental Protection Agency (EPA) under Title 40 of the Code of Federal Regulations, Part 50, Appendix D (40 CFR Part 50).

5.2 Equipment Required

The equipment that is needed to carry out the calibration is commercially available, or it can be assembled by the user. Calibration using a primary ozone standard involves the generation of ozone concentrations that are simultaneously measured by a

primary ozone standard and the instrument undergoing calibration. This procedure requires the following equipment:

1. Zero air source
2. Ozone generator
3. Sampling manifold (inert material such as PTFE or FEP only)
4. Sampling lines (inert material such as PTFE or FEP only)
5. UV Photometer

Use of a certified transfer standard for calibration involves the generation of ozone concentrations, using the calibrated ozone generator, that are measured by the instrument undergoing calibration. This procedure requires the following equipment:

1. Zero air source
2. Certified Transfer Standard
3. Sampling manifold (inert material such as PTFE or FEP only)
4. Sampling lines (inert material such as PTFE or FEP only)

Zero air can be generated either from compressed cylinders or from scrubbed ambient air. If ambient air is used, contaminants such as ozone and nitric oxide must be removed. Detailed procedures for generating zero air are in the EPA's [Technical Assistance Document for the Calibration of Ambient Ozone Monitors](#).

5.3 Instrument Preparation

Prior to calibration, follow the steps below:

1. Turn on the Model 106 Ozone Monitor and allow it to stabilize for a minimum of one hour.
2. Connect the instrument to the manifold on the ozone calibration setup. If a particle filter will be used in normal operation, the calibration must be performed through the filter. The manifold must be vented to atmosphere so that pressure does not build up in the calibration setup. Connection of the Model 106 directly to a pressurized output of any device can damage the ozone monitor.
3. Verify that the flow rate into the manifold is greater than the total flow required by the ozone monitor and any other flow demand drawing from the manifold. The ozone monitor requires a minimum of 0.2 L/min.

5.4 Calibration Setup Preparation

As indicated in the EPA Technical Assistance Document there are several tests that should be performed prior to calibration to ensure the accuracy of the measurements. These tests include:

- Setup check
- Ozone loss test
- Linearity check
- Intercomparison test

5.4.1 Setup Check

A visual inspection of the calibration setup should be performed before calibration to verify that the setup is in proper order. All plumbing connections should be checked and verified to follow the manufacturer's instructions. Any obvious leaks should be fixed and the manifold and sampling lines should be checked for general cleanliness. For more information refer to the manufacturer's User Manual for the primary ozone standard or ozone transfer standard.

5.4.2 Ozone Loss Test

Some ozone may be lost in the calibration setup due to reaction with the walls of the manifold and sampling lines. Any significant loss of ozone must be measured and be subsequently applied to correct the calibration measurements. For more information refer to the manufacturer's User Manual for the primary ozone standard or ozone transfer standard.

5.4.3 Linearity Check

Since the Model 106 is inherently linear over several orders of magnitude, a linearity check provides a test that the instrument is operating properly. Instrument linearity can be checked by comparison to an ozone standard (see Calibration Procedure – Calibration Curve) or by dilution of an ozone measurement. To check the instrument linearity by dilution of an ozone measurement, generate and measure a concentration of ozone near the upper range of ozone monitor (80% of full scale is recommended). Additional ozone concentrations should be generated by accurately diluting the ozone flow with zero air and each concentration should be measured once the instrument reaches a stable response. The accuracy of the linearity test relies on the accuracy of the flow meters used to perform the dilution. The percent of non-linearity is calculated from the formula:

$$R = \frac{F_o}{F_o + F_d} \quad (2)$$

$$E = \frac{C_1 + \frac{C_2}{R}}{C_1} \times 100\% \quad (3)$$

where:

R = Dilution ratio

F_o = Ozone generator flow

F_d = Diluent zero air flow

E = Linearity error, in percent

C₁ = Measured concentration of original concentration

C₂ = Measured concentration of diluted concentration

The linearity error should not be greater than 5%. If the error is greater than 5%, the accuracy of the flow dilution should be checked before assuming that the ozone monitor is not linear. Note that the inherent linearity of the Model 106 is better than the error calculated in this linearity check due to the uncertainty introduced by the flow measurements.

5.4.4 Intercomparison Test

Comparison of the calibration setup with other ozone standards is a good check of the overall accuracy of the setup. If measurements from another ozone standard are found to deviate from the calibration setup greater than the instrument specifications, one of the calibration setups is not accurate.

5.5 Calibration Procedure

A multipoint calibration should be performed within the calibration frequency, any time major disassembly of components is performed, or any time the zero or span checks give results outside of the acceptable limits.

5.5.1 Instrument Preparation

1. Turn on the Model 106-MH Ozone Monitor and allow it to stabilize for a minimum of one hour.
2. Enter the calibration menu (Main Menu\Cfg\Cal\O3) and set the zero (Z) value to 0 and the slope (S) value to 1.00.
3. Connect the ozone monitor to the manifold on the ozone calibration setup. If a particle filter will be used in normal operation, the calibration must be performed through the filter. The manifold must be vented to atmosphere so that pressure does not build up in the calibration setup. Connection of the Model 106 directly to a pressurized output of any device can damage the ozone monitor.
4. Verify that the flow rate into the manifold is greater than the total flow required by the ozone monitor plus any other flow demand drawing from the manifold such as a UV photometer or ozone transfer standard.

5.5.2 Measurement of Zero Air

1. Verify that the zero air supply is on and the ozone generator is off. The same zero air supply used in the ozone generator must be used in the zero air measurement.
2. Allow the Model 106 to sample zero air until the response is stable.
3. Record the average zero air response.

5.5.3 Measurement of Ozone Standards

1. Generate an ozone concentration slightly less than the concentration range of interest and allow the ozone generator to warm up for at least 5 minutes. The same zero air supply used for making zero air measurements must be used in the ozone generator.

2. Allow the Model 106-MH Ozone Monitor to sample the ozone concentration standard until a stable response is measured.
3. Record the average response of the ozone monitor as well as either the average response of the UV photometer or the transfer standard.
4. Generate several other ozone concentration standards. At least 5 ozone concentration standards are recommended over the range of interest.
5. For each ozone concentration standard, record the response of the ozone monitor as well as either the response of the UV photometer or the transfer standard.

5.5.4 Calibration Curve

1. Plot the Model 106-MH Monitor responses (y-axis) versus the corresponding standard ozone concentrations (x-axis).
2. Fit the data to a straight line ($y = mx + b$) using the linear regression technique to determine the calibration relationships, where m =slope and b =intercept.
3. Determine if any points deviate significantly from the line, which is an indication of an error in determining the calibration curve. The error may be due to the calibration setup or the ozone monitor being calibrated. The most likely problems in the ozone monitor are leaks, a malfunctioning ozone measurement scrubber, a contaminated valve, or contamination in the optical setup. See the "Troubleshooting" section of this manual (Section 4.3).
4. The inverse of the slope of the line ($1/m$) is the gain factor (S) and the negative of the intercept ($-b$) is the offset (Z) that need to be applied to the ozone monitor response to calibrate it to the primary ozone standard. For the Model 106-MH, if the intercept is outside of the range from -20 to 20 ppm or the slope is outside of the range from 0.90 to 1.10, this is an indication of a problem in the calibration setup or the ozone monitor being calibrated. The most likely problems in the ozone monitor are leaks, a malfunctioning ozone measurement scrubber, a contaminated valve, or contamination in the optical setup. See the "Troubleshooting" section of this manual (Section 4.3).
5. Enter the calibration menu (Main Menu / Cfg / Cal / O3) in the instrument software and set the calibration parameters Z and S as determined above. The Z value must be entered in units of ppm for the Model 106-MH. If the calibration was performed in other units, convert the Z value to ppm before entering it into the Cal menu.

6. PERIODIC ZERO AND SPAN CHECKS

To ensure the quality of the ozone monitor data, periodic zero and span checks can be performed by following the steps below:

1. A zero check is performed by sampling zero air with the Model 106-MH as described in section 5.5.2 above, "Measurement of Zero Air."
2. A span check is performed by sampling an ozone concentration at the high end of the concentration range of interest as described in Section 5.5.3 above, "Measurement of Ozone Standards."
3. Average measurements from the zero check or span check should be within the instrument specifications. If the measurements are not within specifications, this is an indication of problem in the calibration setup or the ozone monitor being checked. The most likely problems in the ozone monitor are leaks, a malfunctioning ozone measurement scrubber, a contaminated valve, or contamination in the optical setup. See the "Troubleshooting" section of this manual (Section 4.3).

7. LABELED INSTRUMENT PHOTOS

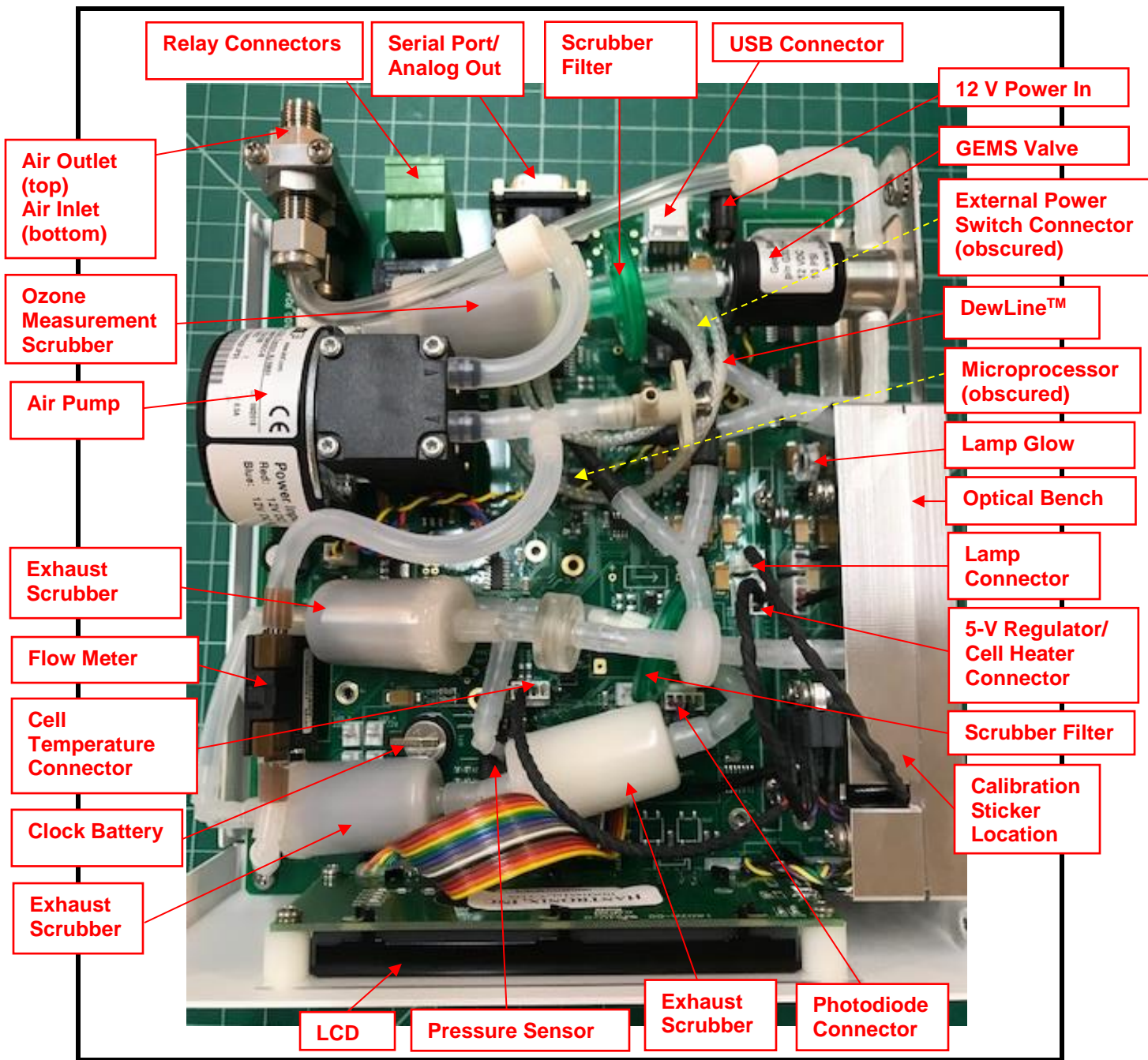

Figure 7.1a. Top View of the Model 106-MH.

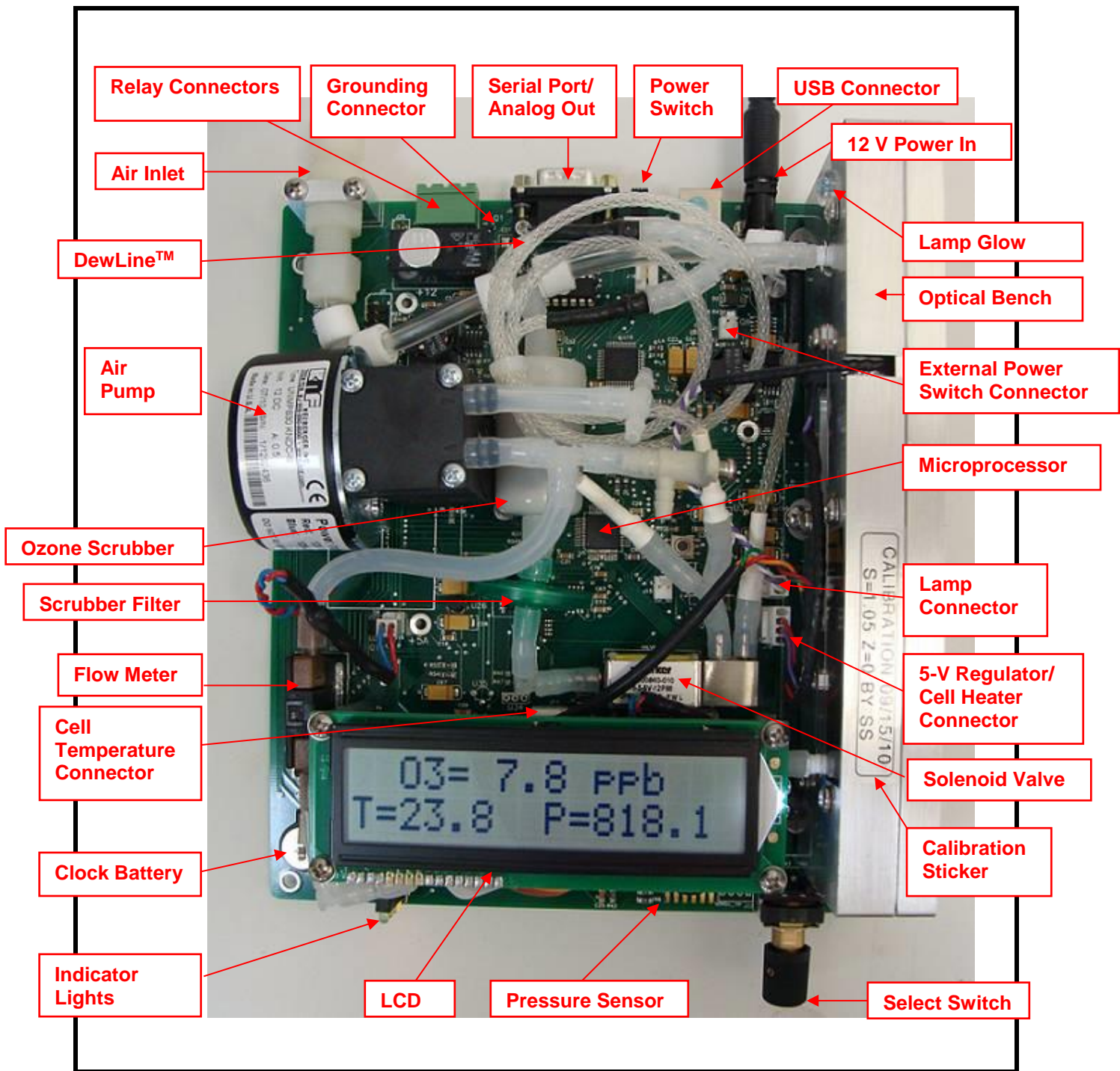

Figure 7.1b. OEM Version of the Model 106-L.
(OEM Version of the Model 106-MH has a smaller optical bench and additional scrubbers.)



Figure 7.2. Front Cover of the Model 106-MH.

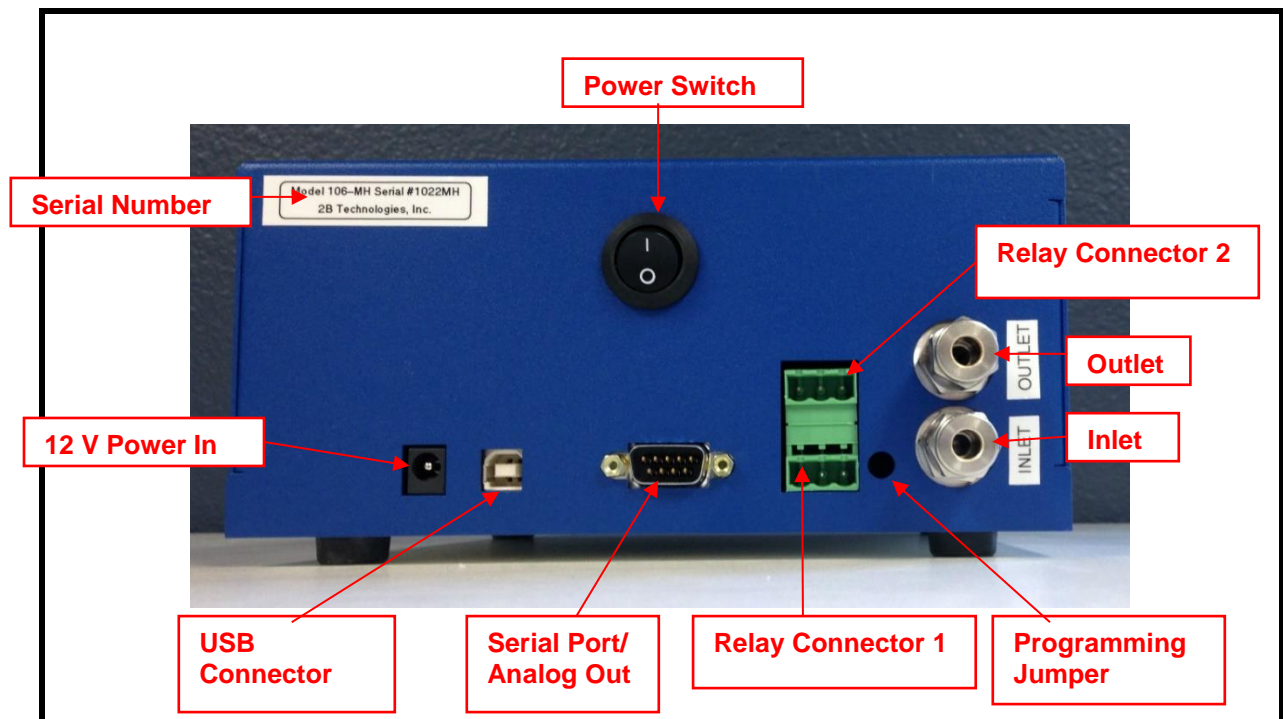

Figure 7.3. Back Plate of the Model 106-MH.

8. PARTS LIST

The following list includes those parts that are user serviceable. Replacement of the solenoid valve requires a knowledge of soldering.

Please see the 2B Technologies website for a full and updated list of parts and pricing: <https://twobtech.com/parts-online.html>

Part Number	Description
SCRBINT	Ozone measurement scrubber, ozone exhaust scrubber (internal)
SCRBEXT	Ozone zeroing scrubber (external)
OZDSP106	LCD display and cable
PDASSEMBLY106	Photodiode assembly and cable
SELECTSWITCH106	Select switch
DEW	DewLine™ (two Nafion tubes in parallel)
RELCON	Relay connector
RS232BRKOUT	RS232 breakout connector
SERCABL	Serial port cable (to computer)
USBCABLE	USB Cable (USB-A to USB-B 2.0 cable)
PWRWIR	Bare wire power cable
CIGADAP	12 V DC cigarette lighter adapter
TEFTYG25	Teflon-lined Tygon® tubing (25 ft)
TEFTYG05	Teflon-lined Tygon® tubing (5 ft)
SILTUB05	Silicone tubing (5 ft)
CLEANLOOP106LM	Cleaning loop set

Appendix A: Using the 2B Technologies Display and Graphing Software

Copyright© 2B Technologies. All rights reserved

Introduction

2B Data Display[®] is an easy way to display and save data from your serial or USB connection.

With easy one-click operations, data are read from your instrument and displayed on an extremely versatile chart. Two items, such as Ozone and Temperature, can be displayed simultaneously on the chart with multiple zoom levels. Data are automatically saved to a .txt file and can optionally be saved to a .CSV file to be read in Excel. Saved data can be restored for later viewing and analyzing on the chart. By requesting an account with 2B Technologies, you can upload your data and view it on a Google Earth overlay.

Downloading the Software

Go to <https://twobtech.com/downloads.html> and select the Software tab. Click the link for “2B Tech Display and Download Software.” Follow the instructions, doing the two installations if needed and choosing to save the “setup.exe” file. Double-click the setup.exe download to launch the 2B Data Display application.

Connecting Devices

Connect to an Ozone Monitor

1. Select the device you are connecting to from Settings: Select Device (use 106-M setting).
2. Click OK.
3. Select the Connection you will be using from Settings: Connection
Choose the settings as follows:
 - a) Port:
 - The default port is “COM1” for computers with a serial port.
 - If using a USB connection, check for the correct port in the “Device Manager” under “Ports” located in: Control Panel : System : Device Manager.
 - If using a USB to Serial adapter, check for the correct port the same as for a USB connection and look for the name of the adapter (e.g., Belkin, Prolific, or other USB to Serial adapter manufacturers).
 - b) Baud Rate: The Default baud rate is 2400. Check your Ozone Monitor’s settings in the “Cfg / I/O” menu and match the software with the monitor’s setting. Note that for the USB port, the baud rate must match the baud rate of the Ozone Monitor at the Monitor’s startup.

- c) Parity: None
 - d) Data Bits: 8
 - e) Stop Bits: One
4. Click Start button in the Instrument Data Capture section in the upper left corner of the main screen.
 - a) The “Save As” window will appear. A default file name will appear which is made of the date and time. You may change the filename and change where it is saved if you wish.
 - b) Click the “Save” button. This will start the data capture software and data will fill into the chart as they are transmitted from the device.
 - c) The red OFF text will change to green ON text. The text: Waiting for data... will appear until data arrives from the instrument. If the instrument measurement frequency is set to 2 seconds, you will see a data point every 2 seconds. Averaging frequencies can be set to 10 seconds, 1 minute, 5 minutes, and 1 hour in the Avg submenu on the instrument.

Connect to Weather Station (Davis Vantage Pro)

1. Be sure the weather station is physically connected to the USB port or Serial port of the computer.
2. Select the COM port for the weather station from *Settings : Weather Connection Settings...*
3. Select “Retrieve Weather Data” from the “Weather Link” menu. A window will appear and the software will try to retrieve the weather station data. If the connection is good, weather data will be displayed in the window. If not, an error message will appear. Try a different com port if the error message appears. You may move this window so it is out of the way or you may close it. The weather data is updated every 5 seconds.
 - Since the Ozone Monitor and the Weather Station both use COM ports, you may have to unplug one of the USB adapters from the PC to determine which device is using which COM port.
4. To bring up the window again if you have closed it, select “Display Weather Data.”

Viewing Data

The Data Grid Tab

1. Make sure the application is connected to a device or that you have opened a previously saved data file.
2. Click the *Data Grid* tab on the right side of the screen.
3. The data lines received from your instrument will be listed in a grid with the latest point at the top.

4. The header contains the device specific variables (e.g., Ozone, Cell Temp...). Log Number is always listed even if your instrument is not set to log.

The Charts Tab

1. Make sure the application is connected to a device or you have opened a previously saved data file.
2. Click the *Charts* tab on the right side of the screen.
3. Select which data items to display from the drop down windows “Data 1” and “Data 2.”
4. The data points will appear in a graph window in the middle of the screen.
5. Adjust the zoom level by pressing the + or – buttons under the *Settings* button (upper right side of screen).
6. Adjust the Y scale or set the *Auto Range* feature by pressing the *Settings* button
 - a. Check the *Auto Range* box to use autoscaling.
 - b. Uncheck the *Auto Range* box to manually set Y max and Y min for the Data 1 and Data 2 fields.

The Buffer Tab

- Selecting the Buffer tab brings up a buffer window, similar to Tera Term or HyperTerminal, where all data from the serial port are displayed.
- From this tab, the user can also send commands through the serial port by typing on the keyboard. This is only applicable if the device that is connected accepts serial commands. See the instrument manual for a list of the serial commands.
- This buffer window can also be used for troubleshooting for instances when: the baud rate, device, or serial port is unknown. For example, if the status bar in the “Instrument Data Capture area states “Receiving...” and no data appear in the Data Grid or the Charts, click on the Buffer tab to view the serial data. If the correct device is not selected, no data will be displayed in the Data Grid or the Charts, but data will be displayed in the Buffer window.

Saving Data

Saving Ozone Data to a .txt File

1. Click the *Start* button in the Instrument Data Section to begin collecting data from the instrument.
2. A window will pop up to prompt for the name and location of the file.
3. Click *Save* to begin the data collection.
4. All data read from the ozone monitor through the COM port are written to the .txt file in real time until *Stop* is clicked.

Saving Data to a .CSV or an Excel File

NOTE: Weather data are NOT saved to the .txt file. In order to save weather data, be sure to save a .CSV file after *Stop* is clicked.

1. After collecting data, click the *Stop* button in the Instrument Data Capture Section on the main screen.
2. A window will pop up to ask you if you would like to save to a CSV file as well. Click *Yes*.
3. A default name appears from the date and time of the data capture. You may change the name and path of the file if you wish.
4. Click on the *Save* button.

Opening Files

1. To open a file, click *Open* from the *File* menu.
2. Navigate to the folder where the file was stored.
3. Select either the .txt file or the excel file and press *Open*.
 1. NOTE: To view weather data, you must open the corresponding .CSV file.
4. Choose the correct device associated with the file.
 - a. If you are unsure, open the file in a text editor or Excel to determine which device.

Serial and USB Commands

The menu commands are the same as given in Section 3.15 of this manual.

Appendix B: Model 106-MH Cleaning Procedures (Flow Path)

Summary:

It is recommended that Ozone Monitors be returned to 2B Tech at least once annually for calibration. This includes cleaning of the entire flow path and installation of a new internal ozone measurement scrubber (Figure 7.1). If the flow path becomes contaminated, as evidenced by large positive or negative offset (Z) and/or low slope (S) calibration parameters, it may be necessary to clean the flow path and replace the ozone measurement scrubber. This can be done by the user if desired. The procedure involves the following steps:

1. Remove the top cover.
2. Bypass the ozone measurement scrubber.
3. Bypass the DewLine™ (Nafion tube).
4. Connect a drain tube at the exit of the detection cell.
5. Squirt methanol through the flow path while the instrument is running.
6. Blow dry with clean compressed air or nitrogen while the instrument is running.
7. Check the DewLine™ for contamination.
8. Replace the ozone measurement scrubber.
9. Reconnect plumbing.

Tools needed:

- Phillips head screw driver
- Teflon®-lined Tygon® or other clean, inert tubing such as PTFE, PFA or PVDF
- Methanol (methyl alcohol)
- Squirt bottle
- New ozone measurement scrubber

Photos show the Model 106-M Ozone Monitor, which is similar to the Model 106-MH. Please refer to Figure 7.1 of this manual as you go through this cleaning procedure.

Warning: This procedure makes use of the toxic and flammable solvent methanol, and appropriate care should be taken. Although a relatively safe solvent to work with, as with all solvents appropriate care should be taken. Remove any clothing contaminated with methanol. If methanol contacts your skin, wash the affected areas with soap and water for at least 15 minutes. If methanol gets in your eyes, wash your eyes with water for at least 15 minutes, occasionally lifting and lowering the upper and lower eyelids and seek medical help.

Model 106-M



Procedure:

1. Remove 6 screws from top cover. Remove cover (blue) from base (white).

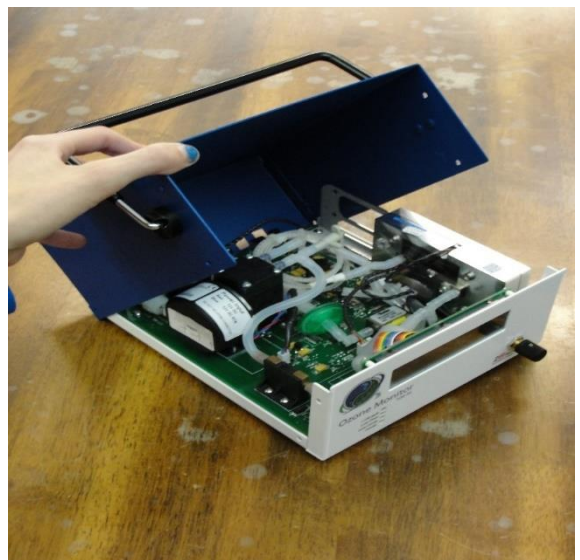

2. Bypass the ozone measurement scrubber and disc particle filter by disconnecting both ends of the scrubber and replacing with a short piece of clean, inert tubing such as Teflon-lined Tygon®, PTFE, PFA or PVDF. **Do not use Tygon!**

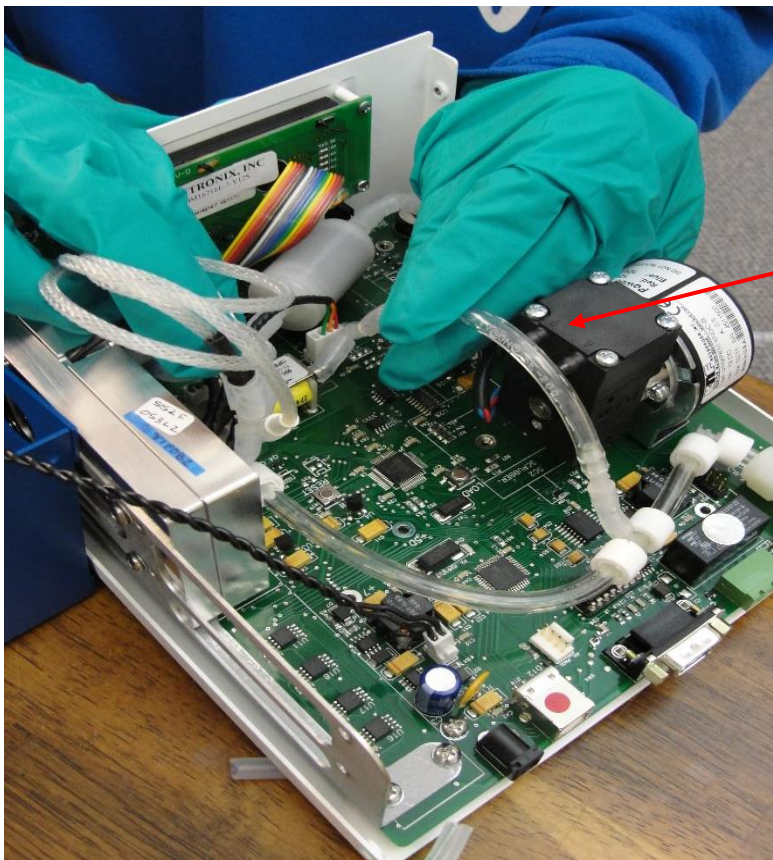
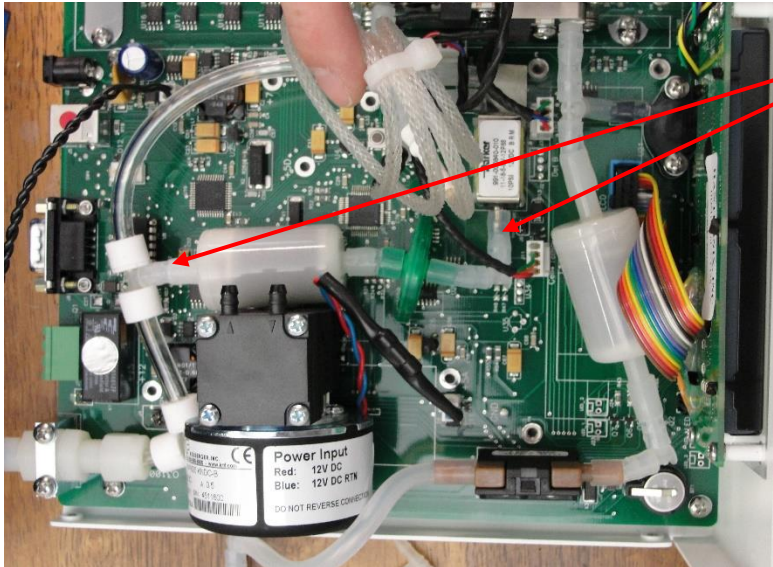

3. Remove the DewLine™ at both ends and replace it with clean, inert bypass tubing such as Teflon-lined Tygon®, PTFE, PFA or PVDF. **Do not use Tygon!**

Note that the DewLine™ consists of two sections of Nafion® tubing connected in parallel.

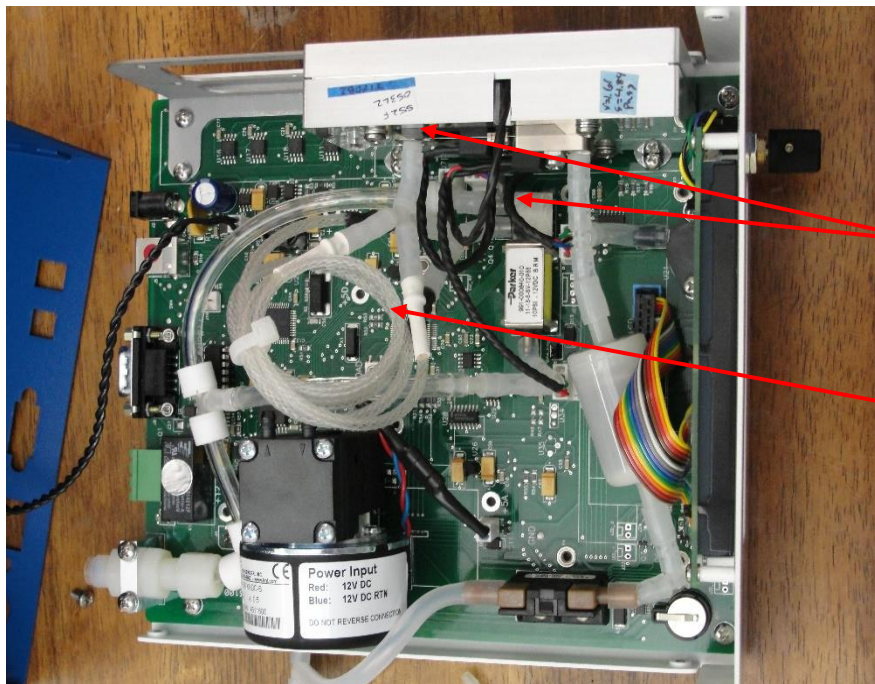

Disconnect at the barbs at these 2 points

DewLine™

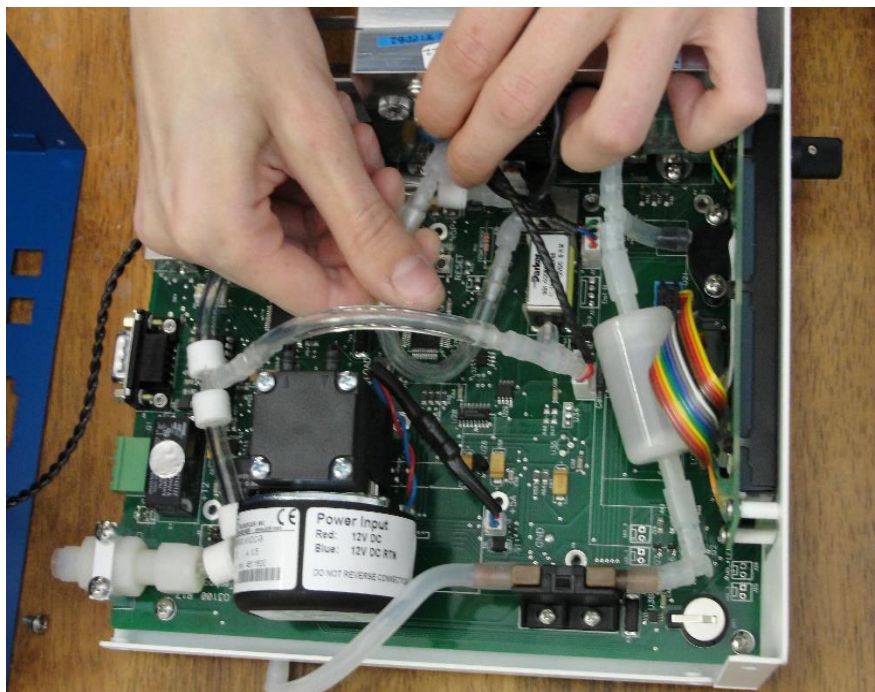

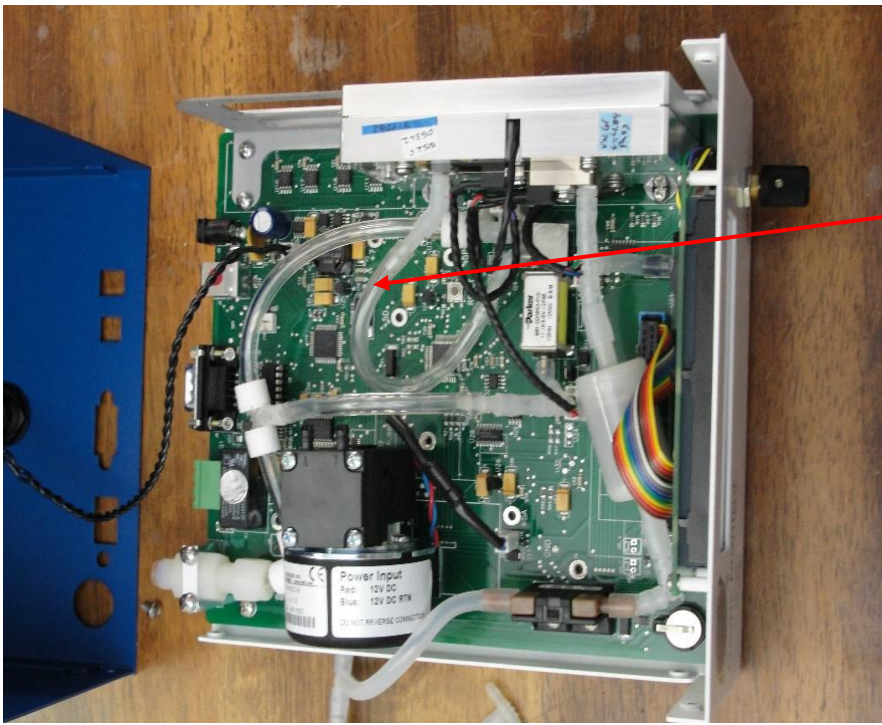

DewLine™ bypass tubing

4. Disconnect the tubing from the outlet of the detection cell and replace with a drain tube. This can be any kind of tubing; silicone tubing is shown here.

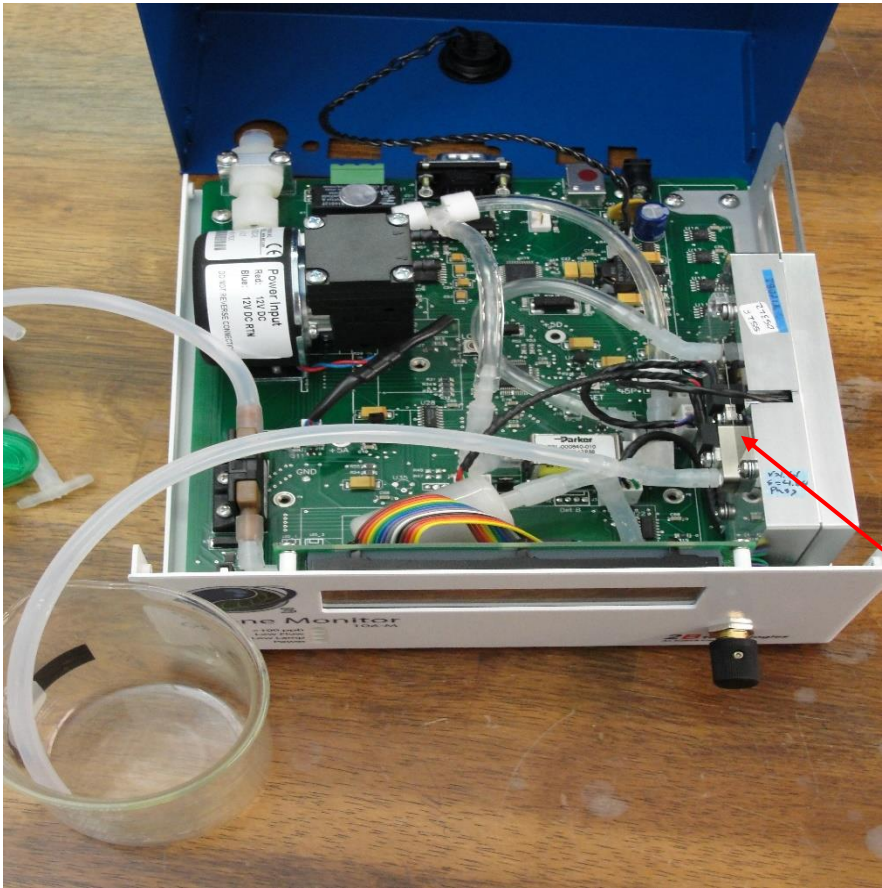

Disconnect here, at the barb that is on the side of the detection cell.



Another view.

5. Put on goggles and plastic or rubber gloves. Carry out the cleaning procedure in a hood or well ventilated area. Make sure there are no sparks or flames nearby.

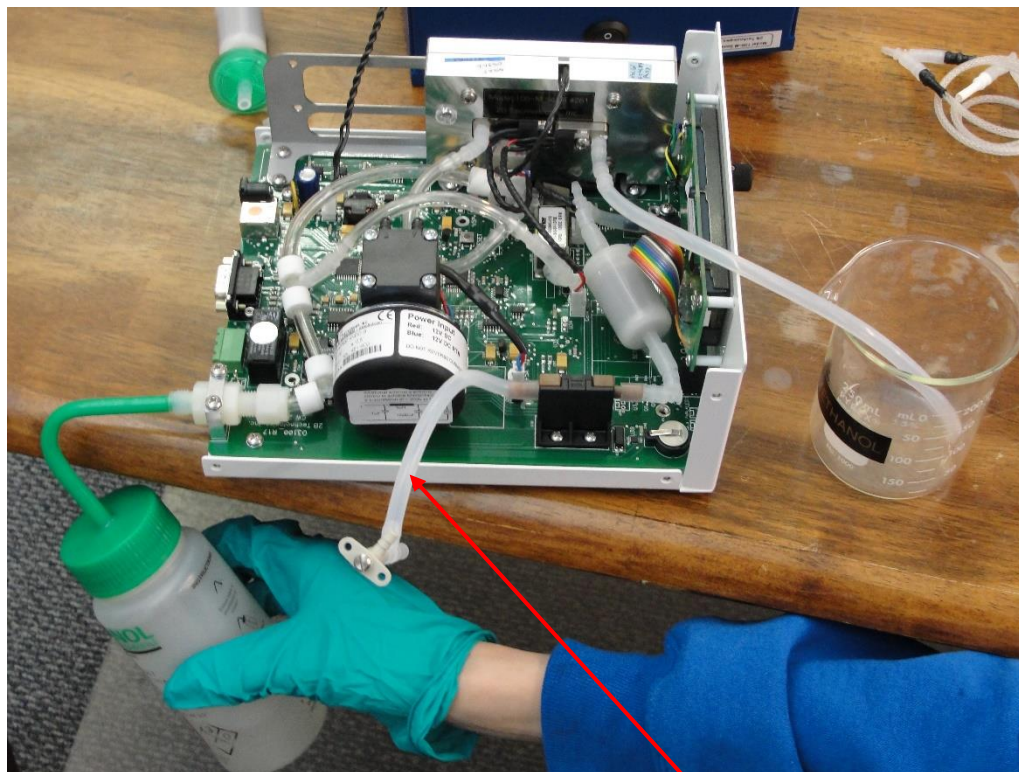

Note that we have removed this pump connection tubing for clarity in taking the photos.

Use a squirt bottle to force methanol through the flow path while the instrument is running. You should pass at least 50 cc of methanol through the instrument. The purpose of having the instrument running is to clean both sides of the 3-way solenoid valve. This valve switches states every 2 seconds.

Collect the waste solvent and dispose of properly. Don't pour methanol down a drain.

6. Dry the flow path with clean, compressed air or nitrogen. Be careful during this step and use low pressure to begin with as large quantities of methanol will spew out initially. **IMPORTANT:** It is necessary that the flow path be completely dry before reconnecting the scrubber.
7. If the DewLine™ has become contaminated (as noted by discoloration), it should be replaced, or returned to 2B Technologies for cleaning.
8. It is recommended that you replace the ozone measurement scrubber (the one you bypassed) during this step. If the flow path was dirty, then the scrubber will be dirty as well. A contaminated ozone measurement scrubber will typically cause a

large offset in the measurement and may re-contaminate the flow path. The ozone exhaust scrubber on the opposite side of the instrument that protects the air pump may be changed at this time as well, although that ozone scrubber has no effect on the ozone measurement.

9. Reconnect the plumbing and replace the instrument covers. The assembled Model 106-MH instrument is shown below as a guide (photo from Figure 7.1 of this manual).

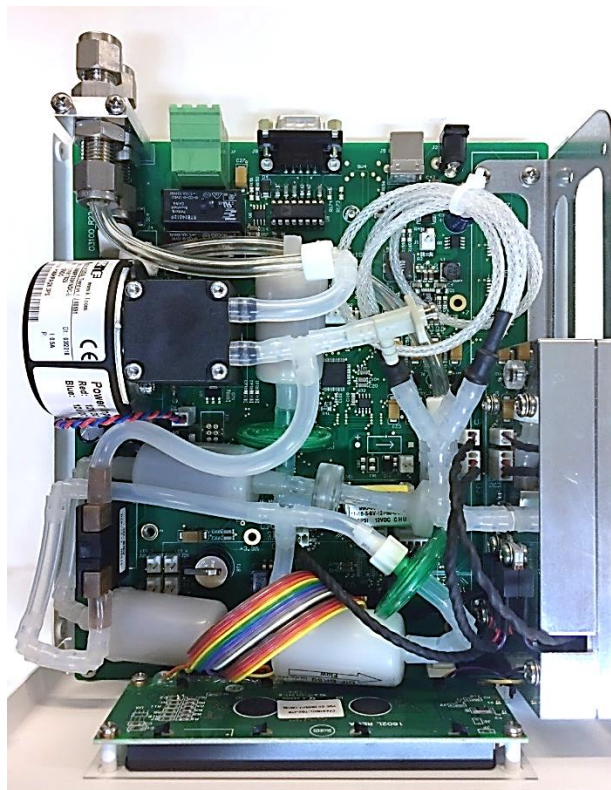

10. We recommend that you run the instrument at least an hour or two after cleaning, to ensure that it is thoroughly dry before you resume measurements. Place an external ozone scrubber on the Model 106-MH air inlet for this step.

Additional Cleaning:

When calibrated, the 106-MH Ozone Monitor should have an offset (Z) in the range ± 1 ppm and preferably ± 0.5 ppm. The slope calibration parameter (S) should be in the range 0.90-1.10 and preferably 0.96-1.06. Offsets and slopes outside this range are most often due to a contaminated flow path. Sometimes it requires more than one cleaning to correct a highly contaminated instrument. If methanol alone is not adequate, it is helpful to do a first cleaning with hexane and a second cleaning with methanol. All of the cautions concerning the use of methanol apply to hexane as well. If cleaning of the flow path in combination with replacing the ozone measurement scrubber does not correct the problem, please return the instrument to 2B Technologies. We will provide you with an estimate of any required repairs before doing the work.

If you have an ozone source, it is helpful to 1) clean the instrument with methanol, 2) expose the instrument to high ozone levels (ppm and above) for several minutes to hours, and 3) clean the instrument again with methanol. The ozone will oxidize contaminants to form polar oxygen-containing compounds that are more soluble in methanol.

Note: You can check the zero of the instrument by running it with an external ozone scrubber attached. Keep in mind that the external ozone scrubber must be clean; otherwise, it will desorb UV-absorbing compounds and cause an apparent offset.

Appendix C: Installation and Use of the USB Connection (for older versions of the Model 106 and/or Windows)

The following procedure describes how to install and use the USB connection for earlier versions of the Model 106-MH (those having 1 relay rather than 2 relays) and/or for PC computers running earlier versions of Windows.

Items Required

- USB-A Type to USB-B-Type Cable
- Model 106-MH Ozone Monitor (older version, 1 relay) **and/or**
- PC Computer with Windows 2000, XP, Vista, or earlier

Driver Installation

1. Download the 106 USB driver from 2B Tech's website, https://twobtech.com/docs/docs_software.htm
2. Navigate to the folder labeled "cdc_NTXP" and double click on it.
3. Unzip the contents to a folder on the desktop or any area you wish.
4. With the Model 106 off, attach the USB cable from the Model 106 to a USB port on the computer.
5. Turn on Model 106. The install wizard should pop up as follows. Select "No, not this time" and click "Next".

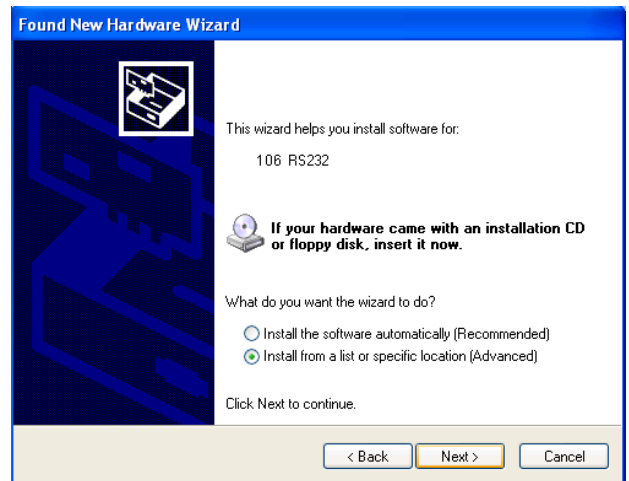

6. In the new popup window, select the "Install from a specific location" option and click "Next".

7. Navigate to folder where you unzipped the cdc_NTXP.

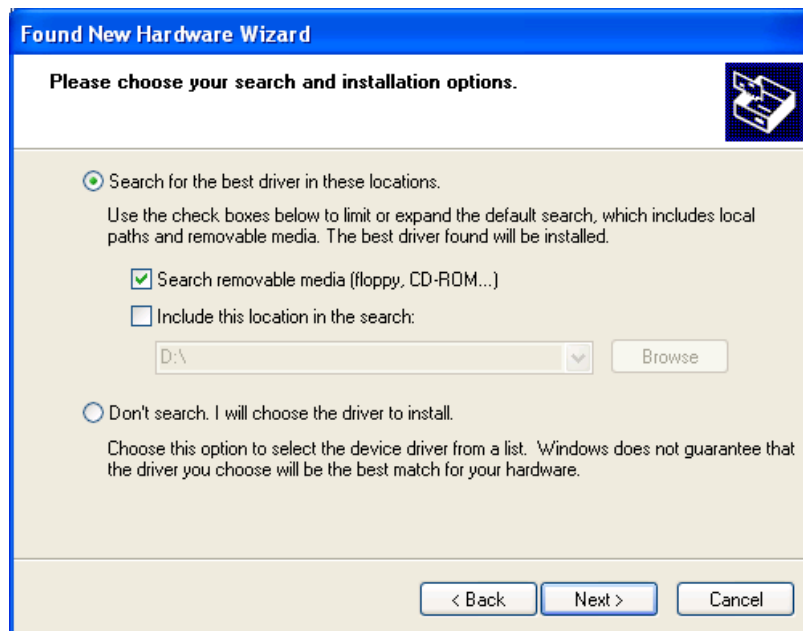

8. Select "Continue Anyway" when this window appears.



9. After a few seconds, the driver will be finished installing.



Determine the Connection Port

After installation is complete, determine which COM port the connection is using. This can be done by the following procedure.

1. If using Windows (XP,Vista,7), go to the control panel and select “System.”
2. Click on the “Hardware” tab.

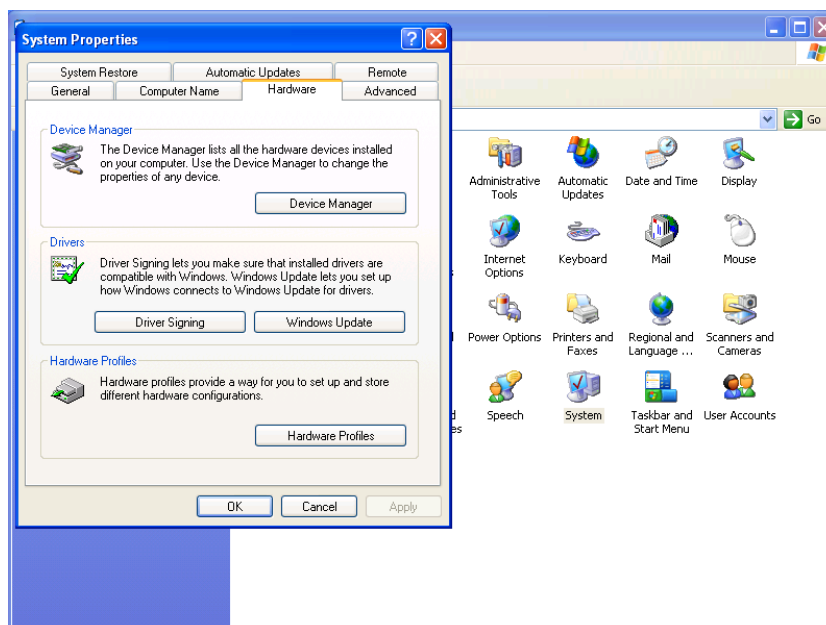

3. Click the “Device Manager” button.
4. Press the “+” sign next to “Ports”.

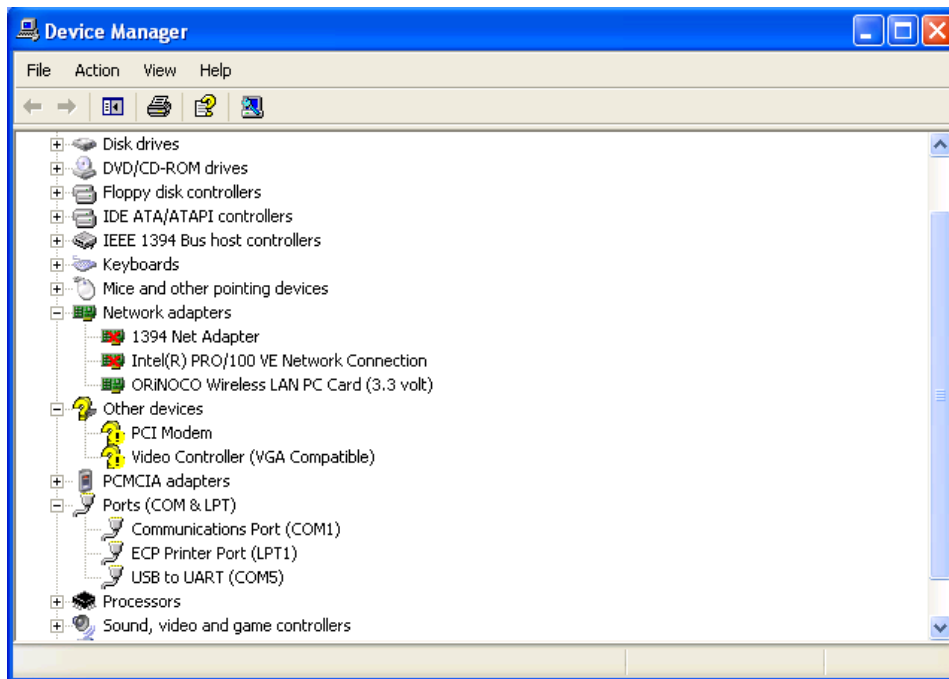

5. In Parenthesis, next to the “USB to UART” listing is the assigned COM port number. This number will be used for the settings for the Terminal emulator or software used to read data from the Model 106.

Using the Connection

- Plug the USB cable in after the powering the Model 106 to ensure correct functionality.
- When setting up your software or terminal emulator, choose the correct com port listed in the Device manager.
- Use these baud rate settings: 2400, 8 bits; no parity; 1 stop bit.
- Use 2B Technologies Display and Graphing Software (free download from https://twobtech.com/docs/docs_software.htm) or other software (such as HyperTerminal or [Tera Term](#)) to read measurement data from the Model 106.